

## OPTIMIZATION OF DRY STORAGE FOR SPENT FUEL FROM G.A. SIWABESSY NUCLEAR RESEARCH REACTOR

R. Ratiko<sup>1</sup>, S.A. Samudera<sup>2</sup>, R. Hindami<sup>2</sup>, A.T. Siahaan<sup>2</sup>, L. Naldi<sup>2</sup>, D. Hapsari<sup>2</sup>,  
T.M.I. Mahlia<sup>3</sup>, N. Nasruddin<sup>2\*</sup>

<sup>1</sup>National Nuclear Energy Agency of Indonesia (BATAN), Tangerang 15314, Indonesia

<sup>2</sup>Department of Mechanical Engineering, Faculty of Engineering, Universitas Indonesia, Kampus UI Depok, Depok 16424, Indonesia

<sup>3</sup>Department of Mechanical Engineering, College of Engineering, Universiti Tenaga Nasional, Selangor 43009, Malaysia

(Received: September 2017 / Revised: November 2017 / Accepted: December 2017)

### ABSTRACT

This study proposes a method of optimizing the dry storage design for nuclear-spent fuel from the G.A. Siwabessy research reactor at National Nuclear Energy Agency of Indonesia (BATAN). After several years in a spent fuel pool storage (wet storage), nuclear spent fuel is often moved to dry storage. Some advantages of dry storage compared with wet storage are that there is no generation of liquid waste, no need for a complex and expensive purification system, less corrosion concerns and that dry storage is easier to transport if in the future the storage needs to be sent to the another repository or to the final disposal. In both wet and dry storage, the decay heat of spent fuel must be cooled to a safe temperature to prevent cracking of the spent fuel cladding from where hazardous radioactive nuclides could be released and harm humans and the environment. Three optimization scenarios including the thermal safety single-objective, the economic single-objective and the multi-objective optimizations are obtained. The optimum values of temperature and cost for three optimization scenarios are 317.8K (44.7°C) and 11638.1 US\$ for the optimized single-objective thermal safety method, 337.1K (64.0°C) and 6345.2 US\$ for the optimized single-objective cost method and 325.1K (52.0°C) and 8037.4 US\$ for the optimized multi-objective method, respectively.

*Keywords:* Decay heat; Dry storage; Multi-objective optimization; Spent fuel

### 1. INTRODUCTION

One major problem related to nuclear research and power plants is radioactive waste. Spent fuel is a hazardous radioactive waste product that produces the highest amount of radiation. Consequently, spent fuel produced by a nuclear power plant and nuclear research reactor must be stored safely so it cannot harm humans and the environment. Treatment of standard spent fuel starts with storing it inside a reactor pond for at least 100 days, and it is then transferred to wet storage. After three to five years stored in the wet storage, the decay radiation and heat produced by the spent fuel decreases to the allowed parameters that can then be transferred into dry storage. Some advantages of dry storage compared with wet storage are that there is no generation of liquid waste, there is no need for a complex and expensive purification system, less corrosion concerns, accidents can be dealt with more easily, and dry storage is more mobile.

---

\*Corresponding author's email: nasruddin@eng.ui.ac.id, Tel: +62-21-7270032, Fax: +62-21-7270033  
Permalink/DOI: <https://doi.org/10.14716/ijtech.v9i1.775>

There are several studies on dry storage of spent fuel. For example, Botsch et al. studied the storage period, in particular, the safe enclosure of radioactive materials and the safe removal of decay heat (Botsch et al., 2013). The safety aspect of safe enclosure of radioactive materials in dry storage casks can be achieved by using a double-lid sealing system, while the safe removal of decay heat can be achieved through the proper design of storage containers. In addition, a study on the temperature history of a concrete silo dry storage system for Canada Deuterium Uranium (CANDU) spent fuel was performed by Lee et al. (Lee et al., 2016). Their study evaluated the temperature of spent fuel in the concrete silo and assessed the decay and behavior of the spent fuel.

Research from Mirae Yun presented a new method to transport and store spent fuel using a software toolbox (Yun et al., 2017), and this probabilistic-based method develops accident scenarios for spent fuel transportation and storage. A study on the operation time periods of spent fuel interim storage facilities was also conducted by Chang Lee (Lee & Lee 2007), and the study predicted operation time periods of interim storage facilities with the assumption of making a new plan for storage pools and the construction of new nuclear power plants.

The study on the heat removal characteristics of spent fuel dry storage has been researched by Sakamoto et al. to optimize the heat removal of the spent fuel dry storage type vault (Sakamoto et al., 2000). A study on multi-objective optimization of an air conditioning system for interim vault dry storage was also performed by Ratiko (Ratiko, 2012). In his report, he presented a satisfying result for thermodynamic and economic criteria with multi-objective optimization using genetic algorithms. Another study on multi-objective optimization on nuclear energy system was performed by Andrianov et al. They evaluated the application of robust and multi-objective optimization methods for a comparative evaluation of nuclear energy system deployment scenarios (Andrianov et al., 2016). Their study calculates the uncertainty in technical and economical parameters of nuclear energy systems for the IAEA energy planning software.

In dry storage, the decay heat from spent fuel, which decreases after the spent fuel has been stored for several years in wet storage, still needs to be cooled by air natural convection. One of the principles that can be used in this natural convection is the chimney or stack effect. There are several studies on the stack effect in houses or buildings, and Ji et al. studied the deflection characteristic of flame with the airflow induced by the stack effect (Ji et al., 2017). The results in their study determined the airflow velocity induced by the stack effect by positioning the open window that influences the location of the neutral plane. A study on the guidelines of the stack effect for tall, mega tall, and super tall buildings was performed by Simmonds and Zhu (Simmonds & Zhu, 2013). Their study revised the calculations for the stack effect for tall (taller than 200 m), mega tall (taller than 300 m), and super tall buildings (taller than 600 m) in ASHRAE Technical Committee for Tall buildings, TC 9.12, which only describes buildings with a height no greater than 91 m.

The objective of this study is to analyze an optimum design of spent fuel dry storage simultaneously from thermal safety and economic aspects. The thermal safety aspect considers the temperature of the spent fuel temperature. As mentioned, the decay heat of spent fuel must be cooled to a determined safe temperature. High temperatures of spent fuel could damage the spent fuel cladding, causing leaks or cracks that could cause a release of harmful radioactive nuclides. The spent fuel in dry storage can be cooled using natural air flow from the stack effect. The other important safety aspect, criticality, is not elaborated in this study. The criticality safety value  $K_{\text{eff}}$  for the rack design in this study and for the spent fuel that is discussed in this study is far below the  $K_{\text{eff}}$  limit of 0.95 (Apostolov et al., 2001; Artiani et al., 2017; Standards, 2014). The economic aspect considers the design manufacturing cost. Thermal

safety and economic aspect in this paper are two contradictory aspects. The temperature decrease of the spent fuel can be obtained by increasing the stack height. However, this increases the cost. Therefore, it is necessary to use the multi-objective optimization method, which simultaneously calculates the two objective functions. The optimization would be calculated using some decision variables, the dry storage and stack dimension, and the inside and outside temperature of the dry storage. The multi-objective results are presented in Pareto Frontier using the Topsis method.

## 2. METHODOLOGY

The objective functions of this paper are thermal safety function and cost function. The temperature of the spent fuel is the main concern of the thermal safety function. The airflow that enters the storage must be controlled to keep the temperature in the dry storage at permitted values (between 40°C and 67°C).

The optimization method in this study uses a genetic algorithm, and in this study, the objective is to attain the safest spent fuel temperature and low installation cost.

The research method applied is shown in Figure 1.

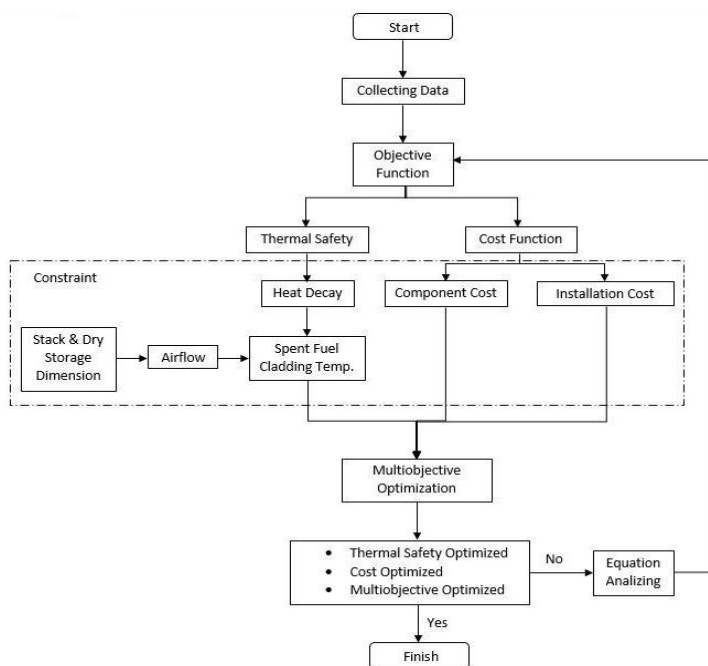

Figure 1 Flow diagram of optimization study

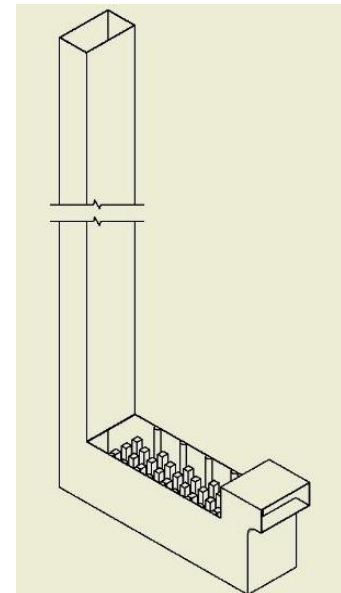



Figure 2 Dry storage design

### 2.1. Specifications of Dry Storage

The dry storage design is based on the vault storage system from Sakamoto et al. (Sakamoto et al., 2000), as seen in Figure 2. In this paper, there were 35 simulated block-shaped storage tubes in the dry storage design, and the specifications of the spent fuel to be placed in dry storage are shown in Table 1.

Stack height has a dimension range between 1 and 3 m. Dry storage length ranges between 0.52 and 0.72 m, and width ranges between 0.35 and 0.48 m. The dimensions of the dry storage design are shown in Figure 3.

Table 1 Specifications of the spent fuel from BATAN

Dimension (mm × mm × mm)	77.1×81×600	
Clad material	AlMg <sub>2</sub>	
Meat dimension (mm × mm × mm)	0.54×62.75×600	
Meat material	U <sub>2</sub> Si <sub>3</sub> Al	
U-235 Enrichment (w/o)	19.75%	
Uranium density (g/cm <sup>3</sup> )	2.96	
U-235 weight per fuel element (g)	250	
U-235 weight per control element (g)	178.6	

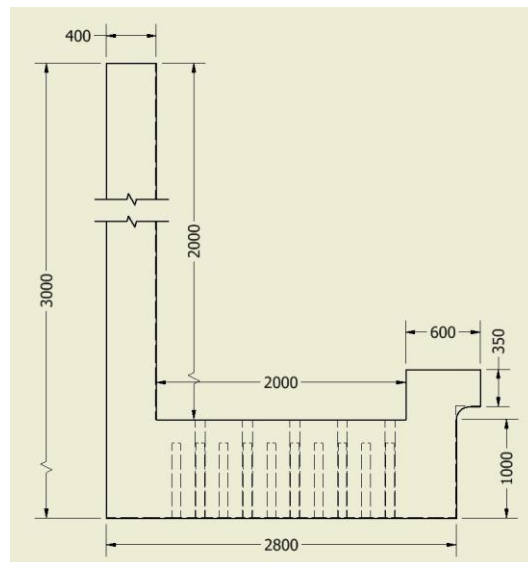

Figure 3 Dimensions of the dry storage design

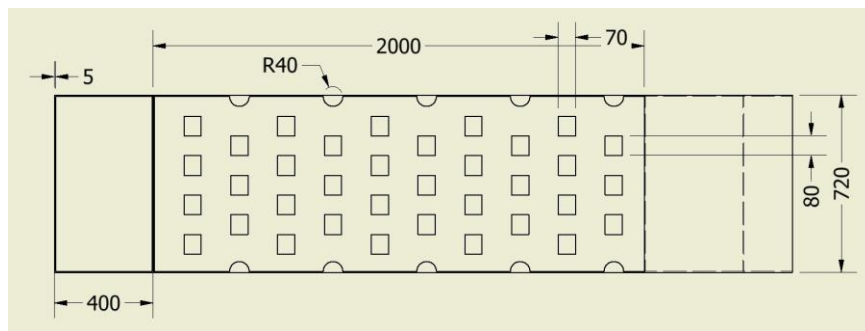

Figure 4 Spent fuel position in dry storage

Dry storage accommodates 35 pieces of spent fuel cladding. Each cladding has a space of 8 cm, and spent fuels are arranged with a staggered model (Figure 4). The dry storage is provided underground, resulting in virtually zero radiation exposure to the public, a low profile, and full protection of the stored spent fuel from man-made and extreme environmental occurrences.

To obtain various results, the dimensions of the storage inlet were varied to provide three different value ranges with the same area. The total inlet area is 0.25 m<sup>2</sup>, so the various lengths and widths of the storage inlets are as follows:

$$(0.52 < l \leq 0.55) \times (0.45 < w \leq 0.48) \text{ m}^2$$

$$(0.55 < l \leq 0.65) \times (0.39 < w \leq 0.45) \text{ m}^2$$

$$(0.65 < l \leq 0.72) \times (0.35 < w \leq 0.39) \text{ m}^2$$

## 2.2. Objective Function

This paper presents the optimization of dry storage design with the objective functions of thermal safety and cost simultaneously. The decision variables used in this optimization are the height of the stack, the length and the width of the dry storage, and the outer temperature and the temperature inside the dry storage.

Thermal safety and cost function in this paper are inversely related, since decreasing the temperature of the spent fuel material requires increased stack height, increasing cost. Therefore, it is necessary to use the multi-objective optimization method, which simultaneously calculates the two objective functions.

The Topsis method was used in this paper to determine the multi-objective optimized values from Matlab calculations. This method selects the best compromise from the available Pareto optimal solutions.

### 2.2.1. Thermal safety function

The thermal safety function is the primary function of this study, and the objective function of safety can be stated as follows:

$$f_{th} \text{ (clad temperature)} \quad (1)$$

The spent fuel temperature must be kept using natural convection in a range between 40°C and 67°C. Higher temperatures may cause oxidization of the cladding of the spent fuel, which could cause cracking. Heat transfer and flow analysis was conducted using ANSYS Fluent software, and the contaminant transport software used CONTAM. The optimization calculation was conducted using Matlab software.

Heat removal was calculated using convective and conductive heat transfer equations, and the free convection was calculated using the following formula:

$$Q = h . A . \Delta t \quad (2)$$

$$Q = \frac{\Delta t}{R_{tot}} \quad (3)$$

and the conduction on each spent fuel can be calculated using the following formula:

$$Q = - k . A . \frac{\Delta T}{\Delta x} \quad (4)$$

$$Q = \frac{\Delta T}{R_{tot}} \quad (5)$$

where

$$R_{cond} = \frac{\Delta x}{k . A} \quad (6)$$

$$R_{conv} = \frac{1}{h . A} \quad (7)$$

The total thermal resistance was calculated to consider the heat transfer from the spent fuel. There are three thermal resistance layers on each spent fuel, and they are shown as a thermal circuit in Figure 5a with their details shown in Figure 5b.

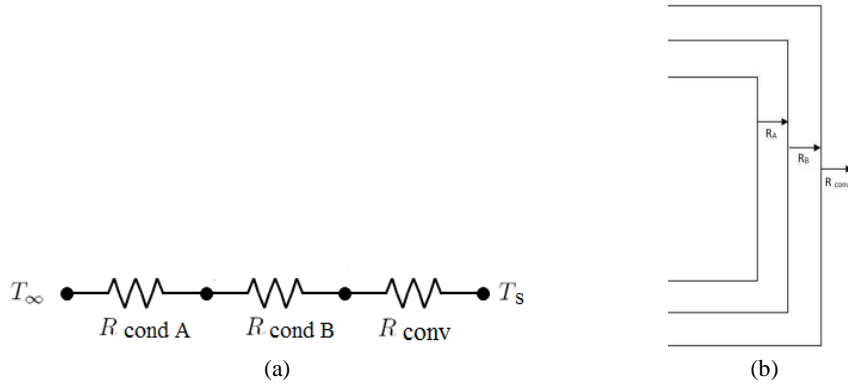

Figure 5 Thermal circuit from spent fuel (a) and Spent fuel material thermal resistance (b)

Using ANSYS Fluent and CONTAM multi-zone indoor air quality software, a dependency equation between temperature and airflow was quantified. The simulation uses a K-epsilon ( $k-\epsilon$ ) turbulence model, which presumes that there is a correlation between viscous stress and Reynold stress on the mean flow;  $k$  represents a partial differential equation that determines the kinetic energy, and  $\epsilon$  represents the rate of dissipation of the turbulent kinetic energy.

### 2.2.2. Cost function

The cost function in this study calculates the design manufacturing cost. The manufacturing cost consists of the price of material used in the design manufacturing plus the installation price. In this study, the design was made from stainless steel with heat-insulating materials, and the objective function of the cost can be stated as the following:

$$\text{Cost} = C_m + C_i \quad (8)$$

The price of material used in the design manufacturing can be calculated by determining the amount of material used in the stack part and the dry storage part. Each calculation can be calculated using the following formula:

$$C_s = \left| \frac{A_{ms}}{A_{mm}} \right| \times \$ 231.92 / \text{m}^2 \quad (9)$$

$$C_{ds} = \left| \frac{A_{m ds}}{A_{mm}} \right| \times \$ 231.92 / \text{m}^2 \quad (10)$$

Thus, the price of material used in the design manufacturing can be stated as follows:

$$C_m = C_s + C_{ds} \quad (11)$$

The installation price the design manufacturing can be calculated using the following formula:

$$C_i = A_i \times C_n \quad (12)$$

where  $C_n$  represents the cost of installation work plus  $C_{iw}$ ,  $C_{ib}$ ,  $C_{ic}$ , and  $C_{ip}$ .

## 3. RESULTS AND DISCUSSION

### 3.1. Temperature Converting from Decay Heat

The temperature of spent fuel is calculated from decay heat, and the calculation of the temperature starts from 1 year to 25 years using conduction and convection equations. Decay

heat data (Watt/Element) are retrieved from BATAN-IAEA Engineering contract (BATAN-IAEA, 1992), and one spent fuel temperature result is presented in Table 2.

Table 2 Decay heat data from BATAN-IAEA Engineering contract (grey shaded) and the temperature values from the calculations

Year	Decay heat (Watt/element)	Calculated temperature (°C)
1	82.6	108.6
2	34.8	65.9
4	12.7	46.3
8	6.5	40.8
16	4.8	39.3
25	3.9	38.5

After 4 years, the temperature decreases from 65°C to 46°C. According to BATAN standards, the safety temperature of dry storage is between 40°C and 67°C (BATAN, 2009). Therefore, in year 4, at a temperature of 46°C, the spent fuel is fit to be transferred from wet storage to dry storage, and the function graph of the calculated temperature values vs year is shown in Figure 6.

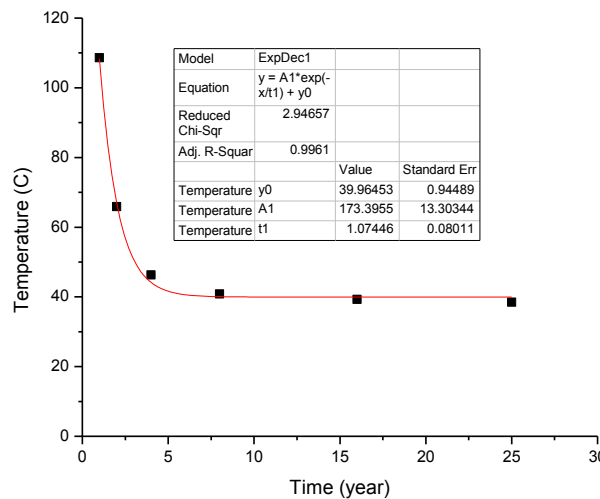

Figure 6 Temperature calculation in graphic form

**3.2. CONTAM and CFD Simulation**

Before conducting the CFD simulation with ANSYS Fluent Software, the dry storage capability in generating mass flow rate should be first determined. CONTAM software is required to determine the mass flow rate, and a scheme is required before creating a design in CONTAM software, as shown in Figure 7.

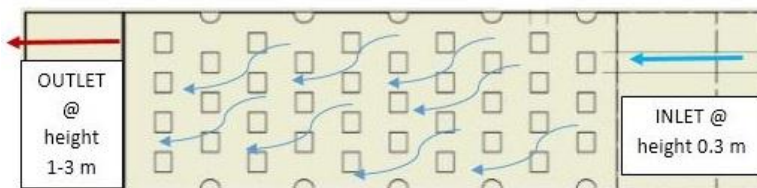

Figure 7 Stack effect simulation using CONTAM software

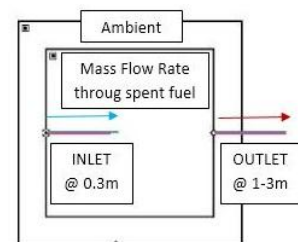

Figure 8 Stack effect simulation using CONTAM software

The blue arrow represents the cold airflow entering dry storage at 0.3 m, while the red arrow represents the airflow exiting at a height ranging between 1 and 3 m, where the temperature at the outlet is greater than the inlet. The increase in temperature is due to the heat transfer from the spent fuel into the air. This scheme is simulated into CONTAM software with the form shown in Figure 8. The natural mass flow of incoming air through inlet and outgoing air through outlet was calculated and simulated using CONTAM. The simulation was also performed by varying the height of the stack from 1 to 3 m. In addition, the temperature inside and outside the dry storage was also varied.

The result of several values of mass flow rate was obtained after the simulation by varying the height and spent fuel temperature. The result of simulation using CONTAM simulation shows that higher stack height and wider surface area generate a higher air flow, and this is shown in Figure 9.

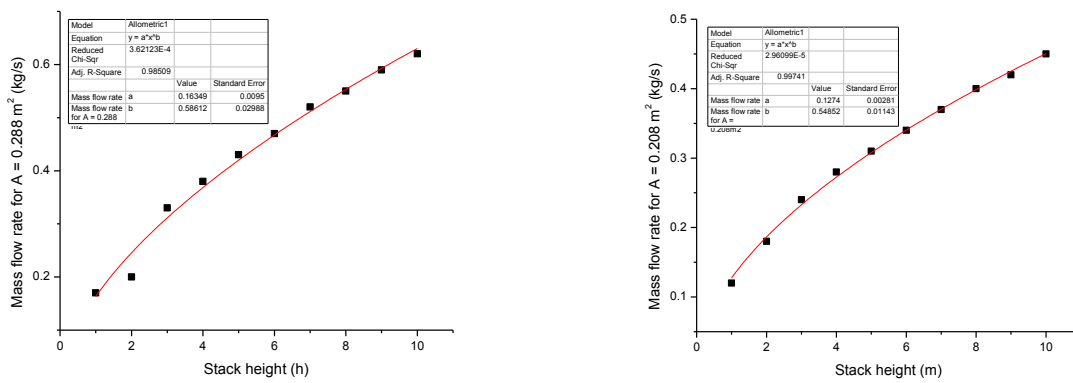

Figure 9 Stack effect simulation using CONTAM software

The temperature for cooling the spent fuel can be found by performing ANSYS Fluent software simulations. Based on the results of the CONTAM simulation, various airflow values can be obtained by changing the height of the stack and the surface area. The airflow obtained was used as an initial value for the ANSYS Fluent simulation. As the airflow increased, the reduction of the spent fuel temperature also increased. ANSYS Fluent simulation uses various value ranges of the dry storage area and uses a convergent design. There are also variations of lengths and widths of the storage inlet, and the temperature contour is shown in Figure 10.

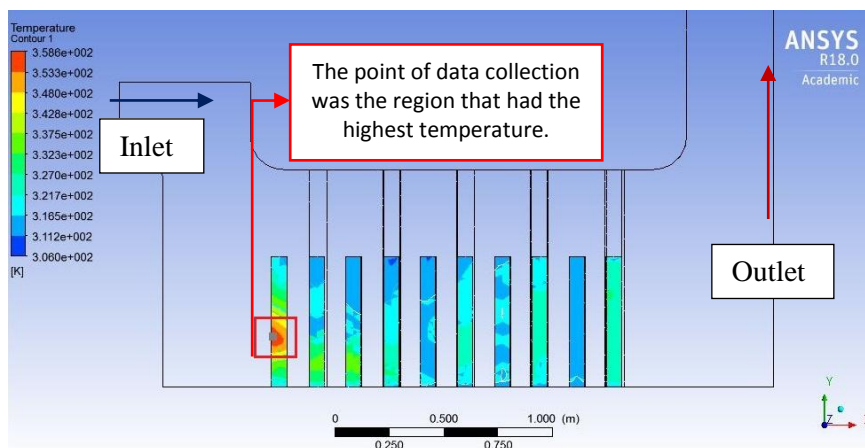

Figure 10 Temperature contour using ANSYS fluent simulation on the Z axis



The extreme temperature or the highest temperature was recorded in the first row of the spent fuel arrangement and was located at the bottom of the spent fuel, because the first row was not exposed to direct airflow. The velocity streamlines of the airflow are shown in Figure 11.

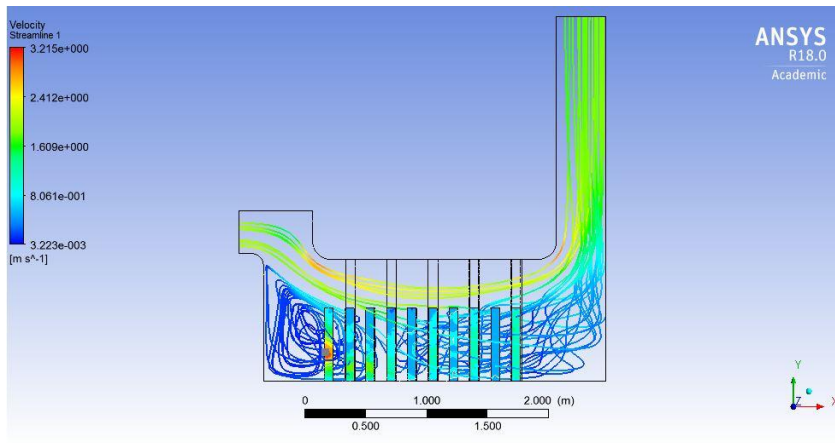

Figure 11 Velocity streamlines using ANSYS fluent simulation

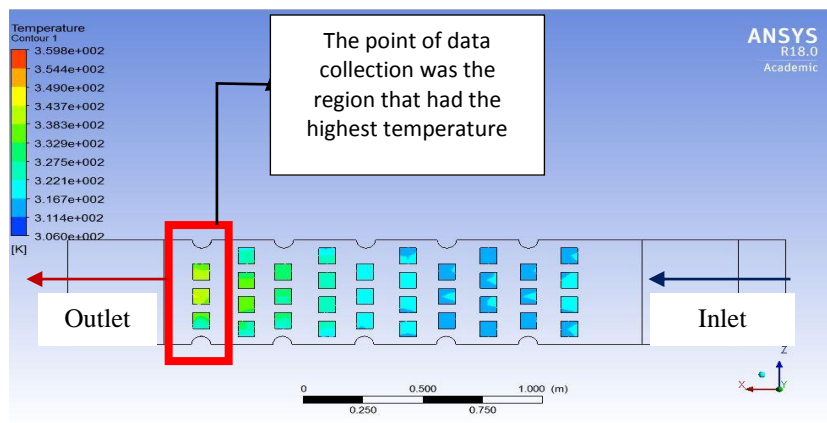

Figure 12 Temperature contour using ANSYS Fluent simulation on the Y axis

In addition to the extreme temperature in the first row of the spent fuel arrangement, the other extreme temperature occurred in the rearmost row, as shown in Figure 12. The other extreme was in this location due to the accumulation of heat from the first row of the spent fuel, so the airflow cooling the next row of spent fuel was hotter than the airflow in the dry storage inlet.

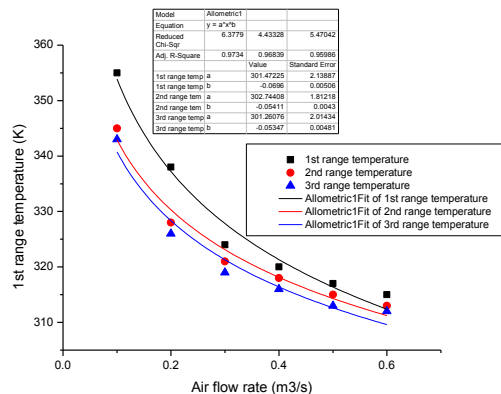

Figure 13 Result of ANSYS simulation with varied value ranges of dry storage area

The result from temperature simulation in ANSYS Fluent was converted to a graph and is shown in Figure 13.

### 3.3. Optimization using Matlab

In this study, optimization has been conducted using some polynomial equations from the ANSYS Fluent simulation results with some decision variables. The decision variables used in the Matlab calculations are the dry storage surface area (A), the stack height (h), and the dry storage temperature (40–67°C).

Using CONTAM and ANSYS Fluent simulations, the capability of dry storage to generate a mass flow rate were determined and was used to assess the thermal safety function. Both functions are a reference in the optimization to decrease the spent fuel temperature accompanied by the efficient cost.

The decision variables in the thermal safety equations are stack height with a range between 1 and 3 m, inlet length with a range between 0.52 and 0.72 m, and inlet width with a range between 0.35 and 0.48 m. The spent fuel temperature was determined by calculations using the generated heat and the outside air temperature according to the temperatures in Indonesia (from 303 until 306K). The equations for the thermal safety function in Matlab calculations are as follows:

$$\text{temp}(1) = 301.66 \times \dot{V}^{-0.069} \quad (13)$$

$$\text{temp}(2) = 302.92 \times \dot{V}^{-0.054} \quad (14)$$

$$\text{temp}(3) = 301.46 \times \dot{V}^{-0.053} \quad (15)$$

The cost equation, as mentioned previously (Equation 8), is the sum of the material costs and installation costs. Each cost has decision variables such as the height of the stack, the inlet width, the inlet length, and the dimensions of the dry storage.

In the Matlab calculation, cost function was defined as objective 1, and the thermal safety function was defined as objective 2. The equations for the cost function in Matlab calculations are shown as Equation 16, Equation 17, and Equation 18.

$$\text{Cost function} = \text{Cost\_stack} + \text{Cost\_dry storage} \quad (16)$$

$$\text{Cost\_stack} = 287.14 \times 2 \times (x_3 \times x_4 + x_3 \times x_5) \quad (17)$$

$$\text{Cost\_dry storage} = 287.14 \times 2 \times (2 \times x_4 + 2 \times 0.6) \quad (18)$$

The optimum cost function as  $f_1$  and the optimum thermal safety function as  $f_2$  should be determined with some variables: T spent fuel was defined as ( $x_1$ ) with the value between 340 and 353K according to the heat generated by the spent fuel in year 4, T ambient was defined as ( $x_2$ ) with the value between 303 and 306K, stack height was defined as variable ( $x_3$ ) with the value between 1 and 3 m, stack length was defined as ( $x_4$ ) with the value between 0.52 and 0.72 m, and stack width was defined as ( $x_5$ ) with the value between 0.3 and 0.5 m.

Then, all those variables were incorporated into equations in the methodology section. All equations were calculated using Matlab. The optimization results using Matlab software are shown as a graph in Figure 14 in the form of Pareto frontier.

The Pareto frontier shows that if spent fuel needs to cool to a safe temperature, a higher cost is obtained. In addition, the Pareto frontier shows that a high temperature drop is achieved by a

larger mass flow rate. Thus, to obtain a large mass flow rate, a large dry storage dimension is required. The large mass flow rate can decrease the temperature of the spent fuel, so it is safer, but it is inevitable that the cost of material and installation is more expensive. Every function depends on the initial temperature of the spent fuel, the inlet air temperature, stack height, stack length, stack width, and dry storage height.

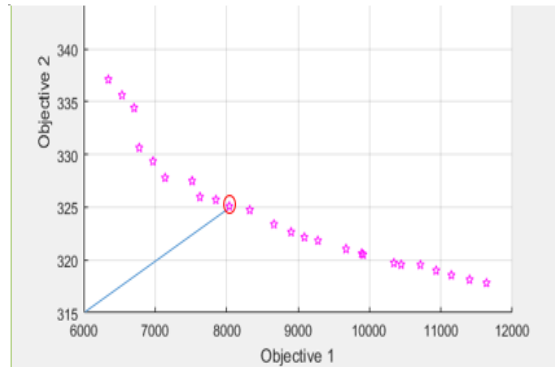

Figure 14 Graph of optimization using Matlab software

Figure 14 shows the optimum thermal safety (minimum spent fuel clad temperature) of 317.8K (44.7°C) and optimum (minimum) cost of 24502 US\$. However, Figure 15 also shows that the cost is high for optimum thermal safety and that the temperature is high for optimum cost.

Using TOPSIS method, the compromise results can be obtained. The arrow point in Figure 14, indicates the compromised alternative with 325.1K (51.9°C) temperature and 8037.4 US\$ cost. Indeed, these compromised results (multi-objective optimized) reveal that the optimum thermal safety value is not as low as the optimum thermal safety in single thermal safety optimization, but the optimum cost value is also not as high as the optimum cost in single thermal safety optimization.

The optimum decision variables of three optimization scenarios are shown in Table 3.

Table 3 Functions and variables selected by the TOPSIS method

Functions	Cost US\$	Thermal safety/ spent fuel temperature (K)	Inside temp. (K)	Outside temp. (K)	Stack height (m)	Stack length (m)	Stack width (m)
Thermal safety optimized	11638.1	317.8	317.9	300.1	2.9	0.65	0.48
Cost optimized	6345.2	337.1	316.0	302.8	1.0	0.52	0.45
Multi-objective optimized	8037.4	325.1	317.9	300.3	1.5	0.6	0.5

#### 4. CONCLUSION

Based on the optimization results, the spent fuel from BATAN can be transferred from wet storage to the dry storage designed in this study after 4 years of storage. In addition, this report shows that the passive cooling system in the dry storage that uses a stack effect can decrease the temperature to safe parameters.

The optimum values of temperature and cost at the single-objective thermal safety optimization are 317.8K (44.7°C) and 11638.1 US\$, whereas the optimum values at the single-objective cost optimization are 337.1K (64.0°C) and 6345.2 US\$. Using multi-objective optimization, the optimum values of temperature and cost are 325.1K (52.0°C) and 8037.4 US\$, respectively.

## 5. NOMENCLATURES

$H_v$	Heat removal caused by airflow (dimensionless)	$V$	Volume of room or space ( $m^3$ )
$R_v$	Radiation removal caused by airflow (dimensionless)	$C_m$	Material cost (\$)
$C_d$	Drag Coefficient (K/m)	$C_i$	Installation cost (\$)
$A_s$	Stack area ( $m^2$ )	$C_s$	Material cost for stack manufacturing (\$)
$g$	Gravity acceleration ( $9.81 m/s^2$ )	$C_{ds}$	Material cost for dry storage manufacturing (\$)
$h_s$	Stack height (m)	$A_{ms}$	Surface area of material used in stack part ( $m^2$ )
$T_i$	Temperature inside the stack (K)	$A_{m_{ds}}$	Surface area of material used in dry storage part ( $m^2$ )
$T_o$	Temperature outside the stack (K)	$A_{mm}$	Surface area of material on the market ( $m^2$ )
$Q$	Heat transfer (Watt)	$C_n$	Cost of the type of work that must be done in the installation (\$)
$A$	Area ( $m^2$ )	$C_{iw}$	Cost of welding work
$\Delta T$	Temperature changes (K)	$C_{ib}$	Cost of bending work
$\Delta x$	Length of insulation (m)	$C_{ic}$	Cost of cutting work
$h$	Convection coefficient ( $W/m^2.K$ )	$C_{ip}$	Cost of painting work
$k$	Conduction coefficient ( $W/m.K$ )	$f_{th}$	Thermal Safety Function
$R_{cond}$	Conduction thermal resistance (K/W)		
$R_{conv}$	Convection thermal resistance (K/W)		
$R_{tot}$	Total thermal resistance (K/W)		
$\dot{V}$	Volume air flow rate ( $m^3/s$ )		
$t$	Time (s)		

## 6. REFERENCES

- Andrianov, A.A., Kuptsov, I.S., Utyanskaya, T.V., 2016. Application of Multi-objective and Robust Optimization Methods for a Comparative Evaluation of Nuclear Energy System Deployment Scenarios. *Nuclear Energy and Technology*, Volume 2(2), pp. 102–107
- Apostolov, T., Manolova, M., Prodanova, R., 2001. Criticality Calculations of Various Spent Fuel Casks-possibilities for Burn Up Credit Implementation. *In: International Meeting 'Nuclear Power in Eastern Europe: Safety, European Integration, Free Electricity Market' and the Tenth Anniversary of Bulgarian Nuclear Society, Bulgaria*, Volume 32(47)
- Artiani, P.A., Mirawaty, Heriyanto, K., 2017. Analysis of Criticality for Spent Fuel of RSG Gas Reactor in Aluminium Storage Rack. *Urania Jurnal Ilmiah Daur Bahan Bakar Nuklir (Urania Journal of Scientific Nuclear Fuel Cycle)*, Volume 23(2), pp. 127–137
- BATAN, 2009. *Safety Analysis Report - Interim Storage for Spent Fuel*.
- BATAN-IAEA, 1992. *Engineering Contract: Transfer Channel and ISSF for BATAN, Preliminary Design Package*. November
- Botsch, W., Smalian, S., Hinterding, P., Voelzke, H., Wolff, D., Kasperek, E., 2013. Safety Aspects of Dry Spent Fuel Storage and Spent Fuel Management. *In: WM2013: Waste Management Conference: International Collaboration and Continuous Improvement, United States*, Volume 45(17), pp. 24–28
- Ji, J., Li, M., Shi, M., Shi, W., Gao, Z., Sun, J., Lo, S., 2017. Deflection Characteristic of Flame with the Airflow Induced by Stack Effect. *International Journal of Thermal Sciences*, Volume 115, pp. 160–168
- Lee, C.M., Lee, K.J., 2007. A Study on Operation Time Periods of Spent Fuel Interim Storage Facilities in South Korea. *Progress in Nuclear Energy*, Volume 49(4), pp. 323–333
- Lee, D-G. Sung, N-H., Park, J-H., Chung, S-H., 2016. An Assessment of Temperature History on Concrete Silo Dry Storage System for CANDU Spent Fuel. *Annals of Nuclear Energy*, Volume 94, pp. 263–271

- Ratiko, 2012. Multi-objective Optimization of Air Conditioning System for Interim Vault Dry Storage. *Journal of Waste Management Technology*, Volume 13(2), pp. 39–50
- Sakamoto, K., Koga, T., Wataru, M., Hattori, Y., 2000. Heat Removal Characteristics of Vault Storage System with Cross Flow for Spent Fuel. *Nuclear Engineering and Design*, Volume 195(1), pp. 57–68
- Simmonds, P., Zhu, R., 2013. Stack Effect Guidelines for Tall, Mega Tall and Super Tall Buildings. *International Journal of High-Rise Buildings*, Volume 2(4), pp. 323–330
- Standards, IAEA Safety, 2014. *Criticality Safety in the Handling of Fissile Material*. Vienna
- Yun, M., Christian, R., Kim, B.G., Almomani, B., Ham, J., Lee, S., Kang, H.G., 2017. A Software Tool for Integrated Risk Assessment of Spent Fuel Transportation and Storage. *Nuclear Engineering and Technology*, Volume 49(4), pp. 721–733