

12-15-2022

## The Comparison of Pipe Thickness Selection Method Using Full Flange Rating and non-Full Flange Rating of Cryogenic Services in an LNG Plant Construction

Ari Agustar

*Atma Jaya Catholic University*, aagustar@yahoo.com

Isdaryanto Iskandar

*Atma Jaya Catholic University*, isdaryanto@atmajaya.ac.id

Wahyuaji Narottama Putra

*Universitas Indonesia*, wahyuaji@ui.ac.id

Follow this and additional works at: <https://scholarhub.ui.ac.id/jmef>



Part of the [Ocean Engineering Commons](#), and the [Structural Materials Commons](#)

---

### Recommended Citation

Agustar, Ari; Iskandar, Isdaryanto; and Putra, Wahyuaji Narottama (2022) "The Comparison of Pipe Thickness Selection Method Using Full Flange Rating and non-Full Flange Rating of Cryogenic Services in an LNG Plant Construction," *Journal of Materials Exploration and Findings (JMEF)*: Vol. 1: Iss. 2, Article 3. DOI: 10.7454/jmef.v1i2.1013

Available at: <https://scholarhub.ui.ac.id/jmef/vol1/iss2/3>

This Article is brought to you for free and open access by the Faculty of Engineering at UI Scholars Hub. It has been accepted for inclusion in *Journal of Materials Exploration and Findings (JMEF)* by an authorized editor of UI Scholars Hub.

# The Comparison of Pipe Thickness Selection Method Using Full Flange Rating and non-Full Flange Rating of Cryogenic Services in an LNG Plant Construction

Ari Agustar<sup>1,4,a)</sup>, Isdaryanto Iskandar<sup>2</sup>, Wahyuaji Narottama Putra<sup>3</sup>

Author Affiliations

<sup>1</sup>Program Studi Pendidikan Profesi Insinyur, Atma Jaya Catholic University, Jakarta, Indonesia.

<sup>2</sup>Mechanical Engineering Department, Faculty of Engineering, Atma Jaya Catholic University, Jakarta, Indonesia.

<sup>3</sup>Metallurgy and Materials Engineering Department, Faculty of Engineering, University of Indonesia, Depok, Indonesia.

<sup>4</sup>Layout and Piping Department, SAIPEM, Jakarta, Indonesia.

Corresponding author: <sup>a)</sup>ari.202204070077@student.atmajaya.ac.id

**Abstract.** Significant growth of gas demand as a source of power generation for domestic use and industries, mainly in the developed countries, has forced the effort to secure the gas supplies located thousands of miles away across the sea as an economical way of gas transportation instead of transporting by pipeline. LNG technology was created as the solution. Natural gas is refrigerated below its boiling point (-160°C to -162°C), known as cryogenic temperature or cryogenic service. Material of Construction (MOC) selection report showed that 304/304L and 316/316L Stainless Steel pipe could withstand and be suitable for this type of service. However, the SS pipe price could be much more costly than the CS pipe. An alternative philosophy to the full-flange rating is introduced in this paper to reduce SS pipe thickness without sacrificing safety issues and proper engineering practice. The philosophy of the pipe wall-thickness calculation method utilized in this paper showed no impact on the class 150 rating due to the selected thicknesses being equal or higher. However, the class 300 rating successfully reduced pipe selected thickness for pipe sizes larger than 24 inches ranging from 20.15% to 31.1%, and for class 600 rating successfully reduced the thickness ranging from 6.28% to 16.55% for pipe sizes 10 inches and larger. The overall pipe thickness reduction reduced pipe weight for cryogenic services by approximately 91.84 tons. The philosophy of the pipe wall-thickness calculation method for cryogenic services can be extended to all other services in the entire LNG production train to gain maximum cost savings for the pipe purchasing cost.

**Keywords:** liquefied natural gas; cryogenic service; full flange rating; pipe thickness.

## INTRODUCTION

To date, natural gas is still a significant source of power generation for domestic use and industries. International Energy Agency (IEA) gas market report has shown significant growth in the gas demand in the last 16 years (2005-2021) in the following Fig. 1 [1],

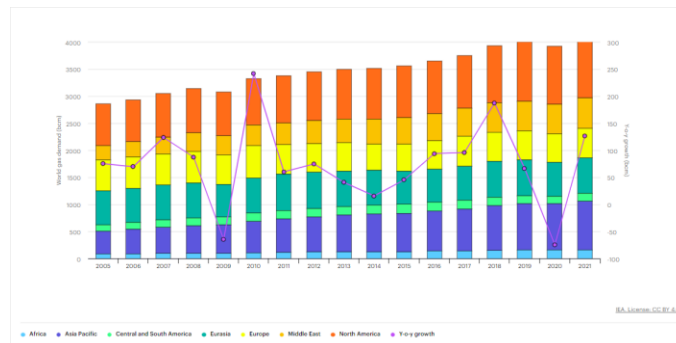

**FIGURE 1.** Evolution of global gas demand from year of 2005 to 2021 [1]

Major gas demand, as seen on the chart, comes from North America & European Countries, not to mention also Japan, subsequently Korea, and Taiwan. However, as already known, significant gas discoveries have primarily been made, such as in Russia, Iran, Qatar, Turkmenistan, the United States, Venezuela, Saudi Arabia, UAE, Nigeria, and Algeria, as shown in Fig. 2 [2].

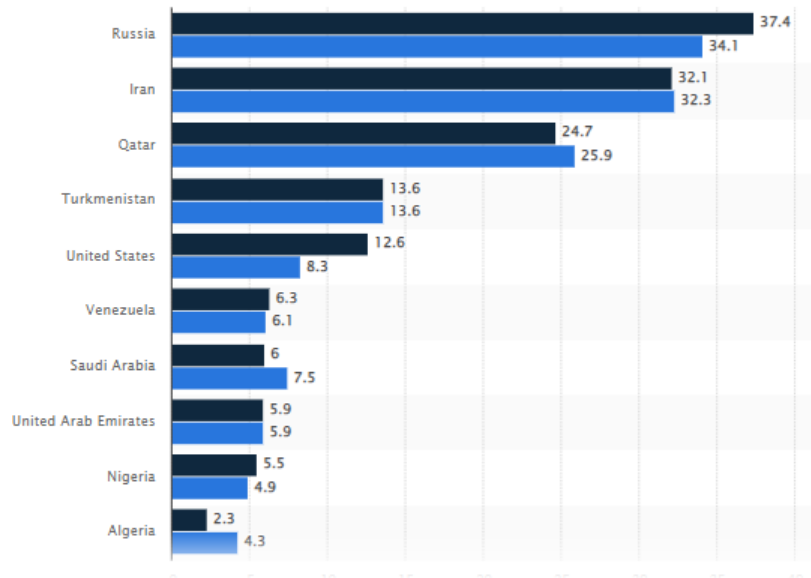
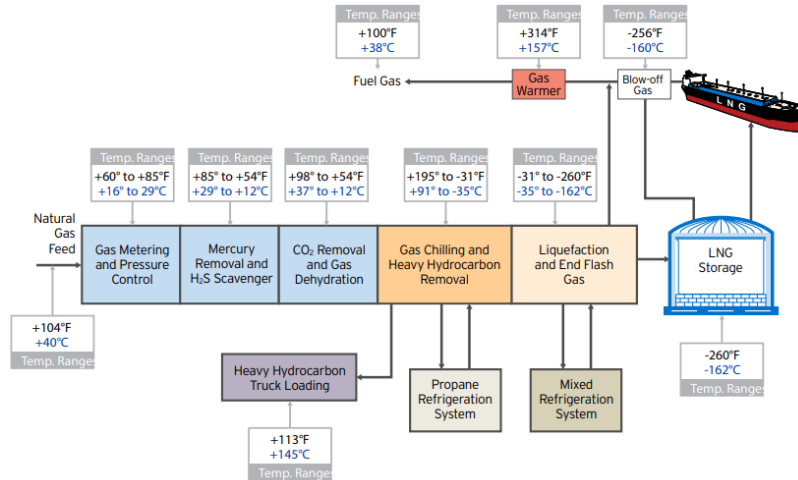

**FIGURE 2.** Leading countries by proved natural gas reserves worldwide in 2010 and 2020. [2]

It is compulsory to secure the gas supplies; however, another big challenge is transporting the gas from the source thousands of miles across the sea to the market, which cannot be reached by pipeline due to impractical and uneconomic.

LNG technology was created at the beginning of the 1960s as an efficient way of transporting natural gas and made its first shipment. Liquefied natural gas (LNG) is natural gas in a liquid form. LNG is produced by refrigerating or treating natural gas to a temperature below its boiling point (-160°C to -162°C). It is methane with a small amount of ethane, propane, and other liquefied petroleum gases and is generally handled at slightly above atmospheric pressure, which requires a very low temperature (also called cryogenic). Converting natural gas to a liquid reduces its volume by about 600 to 1. Which means one LNG Tanker can transport enough LNG to equal 600 Tankers of ships carrying natural gas. Delivering natural gas to the market or end user consist of several activities so-called LNG chain but not limited to: upstream commercial arrangements, gas processing, and liquefaction, LNG shipping arrangements, LNG import and re-gasification, and gas transmission and storage. The LNG chain generally consists of 3 main regions: the production region, transportation, and the consuming region.

This paper limits its discussion to the production region, specifically in constructing an LNG production Plant. Essential to understand that an LNG Production Plant, despite of liquefaction processes employed, commonly consists of (1) Onshore Receiving Facilities (ORF) and Condensate Stabilization Units, (2) LNG Train Units and Systems, (3) Storage and Loading Capacities, (4) utility Units. For better understanding, illustrated in the following block diagram, Fig. 3 [3]:



**FIGURE 3.** Natural gas and the liquefaction process by Cameron LNG [3]

The focus of the paper discussion is cryogenic services lie on liquefaction and refrigeration unit and storage and loading facilities.

The upstream LNG and gas industry is based on cross-border, international trade, with production frequently in a region with a challenging commercial environment. LNG gas exploration and development project characteristics are substantial capital costs and long lead times before revenue is seen. Therefore, it has become a primary concern of project management to reduce construction costs without harming the safety of production-operation while maintaining a proper engineering practices. It is essential to define a project's fundamental driving force, which is cost or time [4,5,6].

The execution of a turn-key Project for an industrial facility consists of three main activities: Engineering, Procurement, and Construction, followed by Commissioning and Start-Up. Engineering designs the facilities, produces the list, specifications, and data sheets of all equipment and materials, and issues all drawings required to erect them at the construction site [7]. Engineering design is the first and most critical part of the execution of a project. Engineering writes the music that all project functions will then play: Procurement procures equipment/ material as specified by Engineering, and Construction erects as shown on engineering drawings [7].

One essential and first engineering activity is selecting the correct material of construction (MOC) of the plant. The first step in selecting the material of construction (MOC) is to understand the plant processes and the environmental conditions to which the plant will be subjected. The process information can be obtained from Process Flow Diagrams (PFD) and Heat and Material Balance (HMB) spreadsheets provided by the Process Engineering Discipline. The environmental exposure conditions can be obtained from the basis of the design document. Once this information is collected, a material selection philosophy is developed and discussed with the owner. When the philosophy is agreed upon, the next step is to create Material Selection Diagrams (MSD). Once issued, these drawings are used by the other engineering disciplines to ensure the selected materials are appropriately utilized. Material Selection Diagrams (MSDs) provide a summary of the process loop conditions and the selected materials of construction [8].

As discussed above, the MOC of the cryogenic services is Corrosion Resistant Alloy (CRA) highly alloyed metals, with the majority being 304/304L Stainless Steel and 316/316L Stainless Steel [8]. As the material cost will be one of the main components in an LNG project cost structure, it is necessary to significantly optimize the material selection of piping materials. There will be a big price gap between common carbon steel (CS) and stainless pipe (SS). SS pipe price, in general, is roughly 4 to 8 times higher than CS pipe. The Quantity of SS pipe required depends on the number of lines and sizes in the cryogenic services. This paper focuses on optimizing the SS pipe utilization in cryogenic services to reduce either cost or pipe weight.

The object of investigation is a construction project of a natural gas liquefaction train located in Indonesia with an approximate production capacity of 3.8 million tons per annum (MTPA) operated by ABC Ltd., an International Oil Company (IOC).

## INVESTIGATION AND CALCULATION METHOD

The study was started by scrutinizing the overall project's fluid list and sequentially conducting segregation between cryogenic services (design temperature below  $-46^{\circ}\text{C}$  to  $-196^{\circ}\text{C}$ ) and non-cryogenic services. Once the fluid list with cryogenic services has been identified, the next step is performing pipe wall thickness calculation. The piping system design code for the LNG production plant refers to the American Society for Mechanical Engineers (ASME) B31.3 standard; the required pipe wall thickness under internal pressure is calculated in accordance with paragraph **304.1** of **ASME B31.3**, 2012 edition [10].

As the selected material in the mentioned LNG project is SS304, therefore Pressure-Temperature ratings, which are the maximum allowable working gage pressures in bar units at the temperatures in degrees Celsius, shown in Table 2.2.1 of ASME B16.5 (Shown here as Table 1) or Table 17 of ASME B16.47, generally used for pipe wall thickness calculation:

**TABLE 1.** Table 2.2.1 of ASME B16.5 [11]

Table 2-2.1 Pressure-Temperature Ratings for Group 2.1 Materials							
Nominal Designation	Forgings			Castings		Plates	
18Cr-8Ni	A 182 Gr. F304 (1)			A 351 Gr. CF3 (2)		A 240 Gr. 304 (1)	
18Cr-8Ni	A 182 Gr. F304H			A 351 Gr. CF8 (1)		A 240 Gr. 304H	
Working Pressures by Classes, bar							
Temp., °C	Class						
	150	300	400	600	900	1500	2500
-29 to 38	19.0	49.6	66.2	99.3	148.9	248.2	413.7
50	18.3	47.8	63.8	95.6	143.5	239.1	398.5
100	15.7	40.9	54.5	81.7	122.6	204.3	340.4
150	14.2	37.0	49.3	74.0	111.0	185.0	308.4
200	13.2	34.5	46.0	69.0	103.4	172.4	287.3
250	12.1	32.5	43.3	65.0	97.5	162.4	270.7
300	10.2	30.9	41.2	61.8	92.7	154.6	257.6
325	9.3	30.2	40.3	60.4	90.7	151.1	251.9
350	8.4	29.6	39.5	59.3	88.9	148.1	246.9
375	7.4	29.0	38.7	58.1	87.1	145.2	241.9
400	6.5	28.4	37.9	56.9	85.3	142.2	237.0
425	5.5	28.0	37.3	56.0	84.0	140.0	233.3
450	4.6	27.4	36.5	54.8	82.2	137.0	228.4
475	3.7	26.9	35.9	53.9	80.8	134.7	224.5
500	2.8	26.5	35.3	53.0	79.5	132.4	220.7
538	1.4	24.4	32.6	48.9	73.3	122.1	203.6
550	...	23.6	31.4	47.1	70.7	117.8	196.3
575	...	20.8	27.8	41.7	62.5	104.2	173.7
600	...	16.9	22.5	33.8	50.6	84.4	140.7
625	...	13.8	18.4	27.6	41.4	68.9	114.9
650	...	11.3	15.0	22.5	33.8	56.3	93.8
675	...	9.3	12.5	18.7	28.0	46.7	77.9
700	...	8.0	10.7	16.1	24.1	40.1	66.9
725	...	6.8	9.0	13.5	20.3	33.8	56.3
750	...	5.8	7.7	11.6	17.3	28.9	48.1
775	...	4.6	6.2	9.0	13.7	22.8	38.0
800	...	3.5	4.8	7.0	10.5	17.4	29.2
816	...	2.8	3.8	5.9	8.6	14.1	23.8

Notes :

(1) At temperatures over  $538^{\circ}\text{C}$ , use only when the carbon content is 0.04% or higher.

(2) Not to be used over  $425^{\circ}\text{C}$ .

Pressure-Temperature data, as shown in the table above, is commonly called a full flange rating; however, if less pressure value than in the table for each corresponding class is used, then the so-called non-full flange rating.

Scrutinizing result of the overall project fluid list showed that there are four piping classes considered cryogenic services in which operating temperatures are continuously below  $-50^{\circ}\text{C}$ , comprised of one of 150 ratings, one of 300 ratings, and 2 of 600 ratings. Further review of the line list involving all four cryogenic piping classes revealed that the maximum pipe diameter size is up to 76 inches for the class 150 rating, up to 80 inches for the class 300 rating, and up to 36 inches for the class 600 rating. This situation became a serious concern as the project was aware that not all the piping line lists for all four cryogenic piping classes identified having line conditions (Pressure-Temperature) precisely the same with full flange rating indicated in Table 2 2.1 of ASME B16.5. If the full flange rating is to be used for pipe wall thickness calculation, many of the cryogenic lines eventually have much more thickness than required, subsequently more weight, and much more costly.

### Pipe Thickness Calculation Philosophy

The wall thickness calculation for cryogenic services is calculated based on the following philosophy:

- a. For Class 150 and 300 systems:
  - Size  $\leq 24$  inches, the maximum pressure in accordance with Pressure-Temperature rating table 2-2.1 in ASME B16.5 is used (Full Flange Rating).
  - Size  $\geq 26$  inches, design pressure based on the most severe Pressure-Temperature line condition for each piping class (Non-Full Flange Rating).
- b. For class 600 and above, design pressure is based on each piping class's most severe Pressure-Temperature line condition (Non-Full Flange Rating).

Full vacuum condition that requires separate pipe wall thickness calculation to withstand external pressure is not considered to simplify this study.

Based on the philosophy above, the following are the Pressure-Temperature conditions to be used in the pipe wall thickness calculations:

**TABLE 2.** Pressure-Temperature condition summary

Flange Rating	Pipe Size	Full Rating		Non-Full Rating	
		Pressure (barg)	Temperature ( $^{\circ}\text{C}$ )	Pressure (barg)	Temperature ( $^{\circ}\text{C}$ )
Class 150	$\leq 24$	19	38	N/A	N/A
	$> 24$	19	38	12.7	180
Class 300	$\leq 24$	49.6	38	N/A	N/A
	$> 24$	49.6	38	37.3	80
$\geq$ Class 600	All	99.3	38	82.7	70

N/A: Not Applicable

## RESULTS AND DISCUSSIONS

Pipe wall thickness calculations against internal pressure are performed for all four cryogenic piping classes, both using full flange rating and non-full flange rating, with results can be seen in the following Tables:

TABLE 3. Pipe wall-thickness calculation result for class 150

Class 150						
Size (inch)	Full Rating Thk (mm)	Non-Full Rating Thk (mm)	Selected Thk (mm)	Thk different (Full rating VS Non-Full Rating)	Thk different (Selected Thk VS Full Rating)	Selected Thk VS Full Rating Thk
1/2	0.17		2.77			OK
3/4	0.21		2.87			OK
1	0.26		3.38			OK
1 1/2	0.38		3.68			OK
2	0.47		2.77			OK
3	0.70		3.05			OK
4	0.89		3.05			OK
6	1.32		3.40			OK
8	1.80		3.76			OK
10	2.17		4.19			OK
12	2.52		4.57			OK
14	2.74		4.78			OK
16	3.08		4.78			OK
18	3.43		4.78			OK
20	3.78		5.54			OK
24	4.48		6.35			OK
26	4.82	3.45	7.92	39.79%	39.13%	OK
28	5.17	3.69	7.92	40.04%	34.72%	OK
30	5.52	3.94	7.92	40.26%	30.31%	OK
32	5.87	4.18	7.92	40.46%	25.90%	OK
34	6.22	4.42	7.92	40.63%	21.49%	OK
36	6.56	4.66	7.92	40.78%	17.16%	OK
38	6.91	4.90	7.92	40.92%	12.75%	OK
40	7.26	5.15	7.92	41.05%	8.34%	OK
42	7.61	5.39	8.74	41.16%	12.94%	OK
44	7.96	5.63	8.74	41.27%	8.95%	OK
46	8.30	5.87	8.74	41.36%	5.03%	OK
48	8.65	6.12	8.74	41.45%	1.03%	OK
52	9.35	6.60	9.53	41.61%	1.90%	OK
56	10.04	7.08	10.31	41.74%	2.62%	OK
60	10.74	7.57	11.13	41.86%	3.51%	OK
64	11.44	8.06	11.91	41.96%	3.97%	OK
66	11.80	8.30	11.91	42.12%	0.92%	OK
68	12.13	8.54	11.91	42.05%	-1.84%	No OK
72	12.83	9.03	12.70	42.14%	-1.01%	No OK
74	13.20	9.27	14.27	42.33%	7.50%	OK
76	13.52	9.51	14.27	42.21%	5.26%	OK
80	14.22	9.99	14.27	42.28%	0.36%	OK

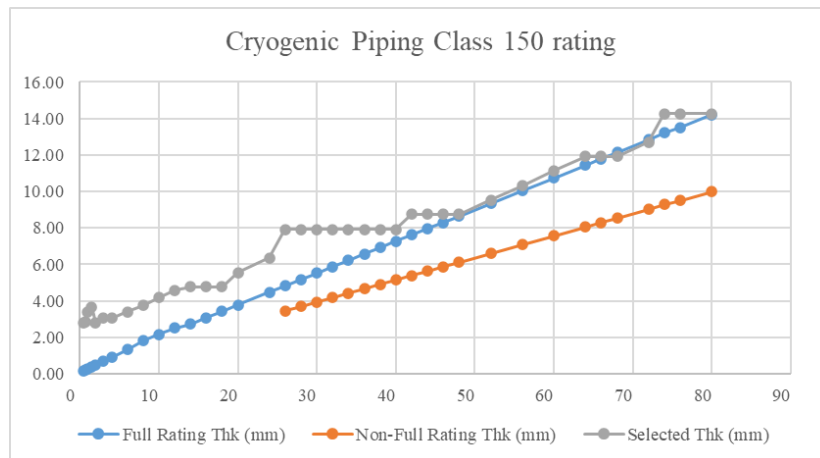
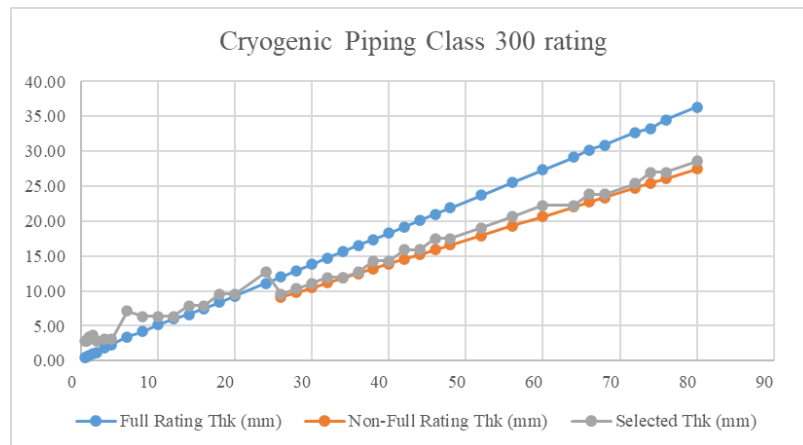

FIGURE 4. Pipe wall thickness comparison for cryogenic piping class 150, full rating VS non-full rating

**TABLE 4.** Pipe wall-thickness calculation result for class 300

Class 300						
Size (inch)	Full Rating Thk (mm)	Non-Full Rating Thk (mm)	Selected Thk (mm)	Thk different (Full rating VS Non-Full Rating)	Thk different (Selected Thk VS Full Rating)	Selected Thk VS Full Rating Thk
1/2	0.43		2.77			OK
3/4	0.54		2.87			OK
1	0.68		3.38			OK
1 1/2	0.98		3.68			OK
2	1.22		2.77			OK
3	1.80		3.05			OK
4	2.32		3.05			OK
6	3.41		7.11			OK
8	4.18		6.35			OK
10	5.14		6.35			OK
12	6.04		6.35			OK
14	6.60		7.92			OK
16	7.50		7.92			OK
18	8.40		9.53			OK
20	9.30		9.53			OK
24	11.11		12.70			OK
26	12.00	9.12	9.53	31.56%	-25.90%	No OK
28	12.90	9.80	10.31	31.63%	-25.15%	No OK
30	13.81	10.48	11.13	31.70%	-24.05%	No OK
32	14.71	11.17	11.91	31.75%	-23.51%	No OK
34	15.61	11.85	11.91	31.81%	-31.10%	No OK
36	16.50	12.51	12.70	31.85%	-29.93%	No OK
38	17.40	13.20	14.27	31.89%	-21.97%	No OK
40	18.31	13.88	14.27	31.93%	-28.30%	No OK
42	19.21	14.56	15.88	31.96%	-20.99%	No OK
44	20.12	15.24	15.88	31.99%	-26.68%	No OK
46	21.00	15.91	17.48	32.02%	-20.15%	No OK
48	21.91	16.59	17.48	32.04%	-25.33%	No OK
52	23.71	17.95	19.05	32.09%	-24.49%	No OK
56	25.51	19.30	20.62	32.12%	-23.69%	No OK
60	27.31	20.67	22.23	32.16%	-22.87%	No OK
64	29.12	22.03	22.23	32.19%	-31.00%	No OK
66	30.20	22.73	23.83	32.86%	-26.73%	No OK
68	30.91	23.38	23.83	32.21%	-29.72%	No OK
72	32.72	24.74	25.40	32.24%	-28.82%	No OK
74	33.25	25.45	26.97	30.66%	-23.29%	No OK
76	34.51	26.09	26.97	32.26%	-27.95%	No OK
80	36.32	27.46	28.58	32.27%	-27.07%	No OK

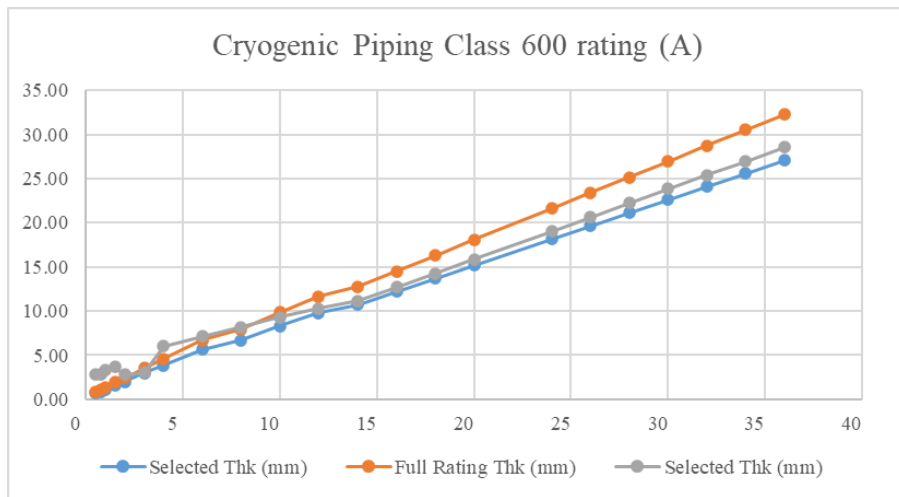

**FIGURE 5.** Pipe wall thickness comparison for cryogenic piping class 300, full rating VS non-full rating



**TABLE 5.** Pipe wall-thickness calculation result for class 600 (A)

Class 600 (A)						
Size (inch)	Full Rating Thk (mm)	Non-Full Rating Thk(mm)	Selected Thk (mm)	Thk different (Full rating VS Non-Full Rating)	Thk different (Selected Thk VS Full Rating)	Selected Thk VS Full Rating Thk
1/2	0.85	0.71	2.77	19.45%	69.25%	OK
3/4	1.07	0.89	2.87	19.45%	62.80%	OK
1	1.34	1.12	3.38	19.45%	60.49%	OK
1 1/2	1.93	1.62	3.68	19.45%	47.52%	OK
2	2.41	2.02	2.77	19.45%	12.95%	OK
3	3.55	2.98	3.05	19.45%	-16.55%	No OK
4	4.57	3.83	6.02	19.45%	24.08%	OK
6	6.73	5.63	7.11	19.45%	5.35%	OK
8	7.97	6.72	8.18	18.59%	2.62%	OK
10	9.85	8.30	9.27	18.75%	-6.28%	No OK
12	11.63	9.78	10.31	18.86%	-12.80%	No OK
14	12.74	10.72	11.13	18.91%	-14.48%	No OK
16	14.52	12.20	12.70	18.98%	-14.33%	No OK
18	16.29	13.69	14.27	19.03%	-14.15%	No OK
20	18.07	15.18	15.88	19.07%	-13.82%	No OK
24	21.64	18.17	19.05	19.13%	-13.61%	No OK
26	23.39	19.63	20.62	19.16%	-13.45%	No OK
28	25.18	21.13	22.23	19.18%	-13.26%	No OK
30	26.96	22.62	23.83	19.20%	-13.14%	No OK
32	28.75	24.11	25.40	19.21%	-13.17%	No OK
34	30.53	25.61	26.97	19.23%	-13.20%	No OK
36	32.28	27.07	28.58	19.24%	-12.94%	No OK



**FIGURE 6.** Pipe wall thickness comparison for cryogenic piping class 600 (A), full rating VS non-full rating.

**TABLE 6.** Pipe wall-thickness calculation result for class 600 (B)

Class 600 (B)						
Size (inch)	Full Rating Thk (mm)	Non-Full Rating Thk(mm)	Selected Thk (mm)	Thk different (Full rating VS Non-Full Rating)	Thk different (Selected Thk VS Full Rating)	Selected Thk VS Full Rating Thk
1/2	0.85	0.71	2.77	19.45%	69.25%	OK
3/4	1.07	0.89	2.87	19.45%	62.80%	OK
1	1.34	1.12	3.38	19.45%	60.49%	OK
1 1/2	1.93	1.62	3.68	19.45%	47.52%	OK
2	2.41	2.02	3.91	19.45%	38.33%	OK
3	3.55	2.98	5.49	19.45%	35.25%	OK
4	4.57	3.83	6.02	19.45%	24.08%	OK
6	6.73	5.63	7.11	19.45%	5.35%	OK
8	7.97	6.72	8.18	18.59%	2.62%	OK
10	9.85	8.30	9.27	18.75%	-6.28%	No OK
12	11.63	9.78	10.31	18.86%	-12.80%	No OK
14	12.74	10.72	11.13	18.91%	-14.48%	No OK
16	14.52	12.20	12.70	18.98%	-14.33%	No OK
18	16.29	13.69	14.27	19.03%	-14.15%	No OK
20	18.07	15.18	15.88	19.07%	-13.82%	No OK
24	21.64	18.17	19.05	19.13%	-13.61%	No OK

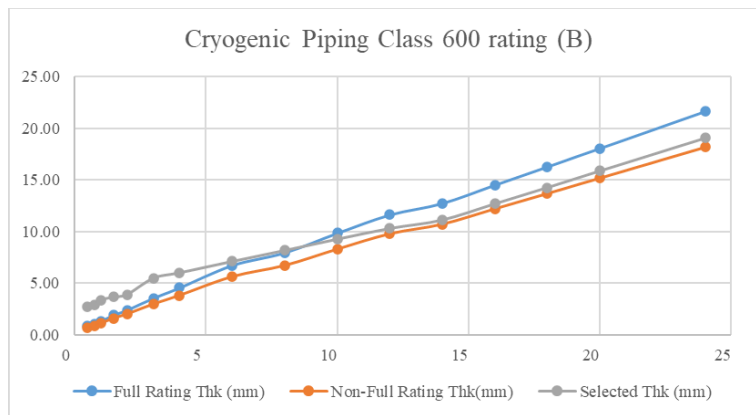

**FIGURE 7.** Pipe wall thickness comparison for cryogenic piping class 600 (B), full rating VS non-full rating.

Calculation results, as seen in **Tables 3 to 6** and Fig. 4 to 7, show a significant wall thickness difference between using the calculation method of full flange rating and non-full flange rating. Non-full flange rating method successfully reduces pipe wall thickness ranging from 39.7% to 42.33% for the class 150 rating, 31.56% to 32.27% for the class 300 rating, and 18.59% to 19.45% for the class 600 rating. Means that there will be a considerable reduction in the total pipe weight of cryogenic services and, subsequently, the cost. The more pipe thickness, consequently, the more weight.

However, what has been discussed this far, only the minimum required pipe wall thickness is calculated as either a full flange rating or a non-full flange rating. Upon completion of the minimum required pipe wall thickness calculation, it is necessary to select the actual pipe wall thickness to be purchased; refer to pipe wall thickness commonly available in the market commercially. The selected pipe wall thickness shall refer to pipe wall thicknesses in the ASME B36.10, ASME B36.19, or API 5L, whichever have the closest thickness value (equal or greater) to the minimum thickness calculation result. **Table 3** shows that for class 150, selected pipe wall thicknesses have less thickness than full rating thickness for sizes 68 and 72. **Table 4** shows that for class 300, pipe size 26 inches and larger, the selected pipe thicknesses are insufficient compared to full rating thicknesses. **Tables 5 and 6** show a similar result: for rating 600, the selected thicknesses for pipe size 10 inches and larger are insufficient compared to full rating thicknesses.

To understand better pipe wall-thickness reduction impact on the total pipe weight and cost, thickness percentage differences in **Table 3 to 6** are used to calculate total additional weight when full flange rating is used, illustrated in the following table showing the actual quantity of each cryogenic service, pipe size wise:

**TABLE 7.** Pipe quantity of cryogenic service class 150

PIPE SIZE	UNIT WEIGHT (Kg/m)	Sum of QUANTITY (m)	Sum of CALC WEIGHT (Kg)	Thickness Increment (if using full rating)	Sum of weight (if using full rating) (Kg)
3/4	2	497	845	no impact	845
1	3	1,842	4,606	no impact	4,606
1 1/2	4	56	224	no impact	224
1/2	1	27	35	no impact	35
2	4	1,827	7,125	no impact	7,125
3	7	2,311	15,018	no impact	15,018
4	8	149	1,247	no impact	1,247
6	14	522	7,208	no impact	7,208
8	20	5,271	105,416	no impact	105,416
10	28	92	2,558	no impact	2,558
12	36	66	2,358	no impact	2,358
14	41	2	66	no impact	66
16	47	254	11,995	no impact	11,995
18	53	2	85	no impact	85
20	69	1	69	no impact	69
24	95	3,766	355,849	no impact	355,849
30	147	4,742	698,467	no impact	698,467
36	195	92	18,036	no impact	18,036
40	237	156	36,941	no impact	36,941
44	282	1	225	no impact	225
46	318	20	6,449	no impact	6,449
48	332	1,467	486,590	no impact	486,590
64	630	1	820	no impact	820
66	971	8	4,273	no impact	4,273
74	656	6	4,201	no impact	4,201
<b>Class 150 Total</b>		<b>23,176</b>	<b>1,770,707</b>		<b>1,770,707</b>

**TABLE 8.** Pipe quantity of cryogenic service class 300

PIPE SIZE	UNIT WEIGHT (Kg/m)	Sum of QUANTITY (m)	Sum of CALC WEIGHT (Kg)	Thickness Increment (if using full rating)	Sum of weight (if using full rating) (Kg)
1/2	1	5	7		
3/4	2	39	66	no impact	66
1	3	118	294	no impact	294
1 1/2	4	2	8	no impact	8
2	4	489	1,907	no impact	1,907
3	7	50	326	no impact	326
4	8	236	1,979	no impact	1,979
6	28	210	5,940	no impact	5,940
10	42	29	1,225	no impact	1,225
12	74	2	126	no impact	126
18	105	609	64,077	no impact	64,077
24	187	3	635	no impact	635
36	282	10	2,683	29.93%	3,486
52	612	19	11,437	24.49%	14,238
66	971	4	3,691	26.73%	4,677
72	1,130	11	12,088	28.82%	15,571
74	1,232	141	173,863	23.29%	214,356
76	1,266	3	3,418	27.95%	4,374
80	1,412	9	12,568	27.07%	15,970
<b>Class 300 Total</b>		<b>1,987</b>	<b>296,337</b>		<b>349,255</b>

**TABLE 9.** Pipe quantity of cryogenic service class 600 (A)

PIPE SIZE	UNIT WEIGHT (Kg/m)	Sum of QUANTITY (m)	Sum of CALC WEIGHT (Kg)	Thickness Increment (if using full rating)	Sum of weight (if using full rating) (Kg)
3/4	2	116	198	no impact	198
1	3	192	479	no impact	479
1 1/2	4	54	214	no impact	214
2	4	1,271	4,956	no impact	4,956
3	7	448	2,914	16.55%	3,396
4	16	157	2,524	no impact	2,524
6	28	1,316	37,234	no impact	37,234
8	43	284	12,070	no impact	12,070
10	60	244	14,719	6.28%	15,644
12	80	41	3,284	12.80%	3,704
14	95	164	15,514	14.48%	17,761
16	123	78	9,605	14.33%	10,981
18	156	449	70,061	14.15%	79,975
20	193	69	13,373	13.82%	15,222
24	277	285	78,920	13.61%	89,661
30	434	136	59,127	13.14%	66,896
32	493	24	11,738	13.17%	13,284
36	624	19	12,049	12.94%	13,608
<b>Class 600 (A) Total</b>		<b>5,347</b>	<b>348,981</b>		<b>387,808</b>

**TABLE 10.** Pipe quantity of cryogenic service class 600 (B)

PIPE SIZE	UNIT WEIGHT (Kg/m)	Sum of QUANTITY (m)	Sum of CALC WEIGHT (Kg)	Thickness Increment (if using full rating)	Sum of weight (if using full rating) (Kg)
1	3	3	6	no impact	6
10	60	4	223	6.28%	237
16	123	3	382	14.33%	437
18	156	1	187	14.15%	214
<b>Class 600 (B) Total</b>		<b>11</b>	<b>799</b>		<b>894</b>

As previously discussed, **Tables 7 to 10** present the project's actual pipe quantity for all four cryogenic piping classes. We can find the total quantity from each piping class size-wise. Thickness differences (in %) between selected thickness and full rating thickness in **Tables 3 to 6** are used as multiplying variables in **Tables 7 to 10** to calculate the new sum of pipe weight when using the full flange rating method. Minus percentage value in **Tables 3 to 6** indicates that the currently selected thickness is not sufficient to compare to the full rating thickness, which means we need to increase the currently selected thickness value.

**Table 7** shows no additional pipe weight since there is no thickness impact due to the selected thickness being greater than the full flange rating thickness on the pipe bill of materials. **Table 8** shows a 52,918 Kg increment in pipe weight, from 296,337 Kg to 349,255 Kg. **Table 9** shows an increment of pipe weight for sizes 3 inches and 10 inches and larger with a total increment of 38,827 Kg, from 348,981 Kg to 387,808 Kg. **Table 10** shows pipe weight increment except for size 1 inch. Pipe weight increased as much as 95 Kg, from 799 Kg to 894 Kg.

## CONCLUSION

The pipe wall-thickness calculation method between full flange rating and non-full flange rating does not have an impact on the class 150 rating for all pipe sizes since the selected pipe thicknesses are equal or greater thickness; however, the class 300 rating shows a significant impact for a size larger than 24 inches, successfully reduced pipe selected thickness ranging from 20.15% to 31.1% to compare to full flange rating thickness. For the class 600 rating, the selected pipe wall thickness for pipe size 10 inches and larger was successfully reduced, ranging from 6.28% to 16.55% compared to the full flange rating thickness. The pipe thickness calculation philosophy for cryogenic services

used in this paper successfully reduced overall pipe thickness, consequently, pipe weight as much as 91,840 Kg or 91.84 tons. With the assumption that the price of 304/304L Stainless Steel pipe is US\$10,000/ ton, pipe purchasing cost for cryogenic services has saved \$918,400 alone. The pipe thickness calculation philosophy used for cryogenic services can be extended to all other services in the entire LNG construction project to gain maximum savings from the overall pipe purchasing activity.

## REFERENCES

1. Evolution of global gas demand, 2005-2021. Available online: <https://www.iea.org/data-and-statistics/charts/evolution-of-global-gas-demand-2005-2021> (accessed on November 18<sup>th</sup>, 2022)
2. Leading countries by proved natural gas reserves worldwide in 2010 and 2020. Available online: <https://www.staticica.com/statistics/265329/countries-with-the-largest-natural-gas-reserves> (accessed on November 18<sup>th</sup>, 2022)
3. Natural Gas and the Liquefaction Process. Available online: <https://cameronlng.com/wp-content>. (accessed on November 18<sup>th</sup>, 2022).
4. Mohamed A. El-Reedy, *Project Management in The Oil and Gas Industry*. Scievenner Publishing, New Jersey 2016. pp. 3.
5. Dhaneswara, D., Agustina, A.S., Adhy, P.D., Delayori, F. and Fatriansyah, J.F., 2018, April. The Effect of Pluronic 123 Surfactant concentration on The N<sub>2</sub> Adsorption Capacity of Mesoporous Silica SBA-15: Dubinin-Astakhov Adsorption Isotherm Analysis. In *Journal of Physics: Conference Series* (Vol. 1011, No. 1, p. 012017). IOP Publishing.
6. Hartoyo, F., 2022. The Optimization of Failure Risk Estimation on The Uniform Corrosion Rate with A Non-Linear Function. *Journal of Materials Exploration and Findings (JMEF)*, 1(1), p.3.
7. Hervé Baron, *The Oil and Gas Engineering Guide*. Editions Technip, Paris, 2010. pp 1-2.
8. Benjamin S. Fults. “The challenges of LNG Materials Selection”, *Annual Conference of the Australasian Corrosion Association*, 2014. pp. 1-14.
9. International Energy Agency, *Security of Gas Supply in Open Markets*. OECD/IEA, 2004. pp. 158.
10. American Society of Mechanical Engineers (ASME) B31.3 Standard, 2012 edition.
11. American Society of Mechanical Engineers (ASME) B16.5.