

# Android-Based Claim System for Electricity Network Customers of PLN Padang Branch

**Received:**  
18 January 2022  
**Accepted:**  
27 July 2022  
**Published:**  
13 August 2022

**<sup>1</sup>Apriade Voutama, <sup>2</sup>Elfina Novalia, <sup>3</sup>Garno**  
*<sup>1</sup>Sistem Informasi, Universitas Singaperbangsa Karawang*  
*<sup>2</sup>Sistem Informasi, Universitas Buana Perjuangan Karawang*  
*<sup>3</sup>Teknik Informatika, Universitas Singaperbangsa Karawang*  
E-mail: <sup>1</sup>[apriade.voutama@staff.unsika.ac.id](mailto:apriade.voutama@staff.unsika.ac.id),  
<sup>2</sup>[elfinanovalia@ubpkarawang.ac.id](mailto:elfinanovalia@ubpkarawang.ac.id), <sup>3</sup>[garno@staff.unsika.ac.id](mailto:garno@staff.unsika.ac.id)  
\*Corresponding Author

**Abstract**—The Padang branch of the State Electricity Company (PLN) is a BUMN responsible for the electricity aspect. Complaints about various electricity problems are difficult for customers, so it is necessary to have a system that can be used as a place for protests and increase PLN's loyalty to customers. The Android-based Claim System is a new application developed to be used by customers as a forum for complaints about electrical problems to the Padang branch of PLN. The Claim System is made into two parts: a Website-based System for PLN and an Android-based Claim Application for customers. Application development using the OOP concept uses UML (Unified Modeling Language) diagrams with the PHP MySql and Android programming languages. The test results were carried out using black box testing with the relevant results. The data of 35 respondents from the assessment questionnaire on the claims system obtained results with an Excellent rating of 78%, a Good rating of 21%, and a Bad rating of 2%. From the analysis results, the Claim System supported by this Android-based Client application can help customers complain about electrical problems quickly and easily.

**Keywords**—PLN; Claim System; UML; Android-based

This is an open access article under the CC BY-SA License.



---

**Corresponding Author:**

Apriade Voutama,  
Sistem Informasi,  
Universitas Singaperbangsa Karawang,  
Email: [apriade.voutama@staff.unsika.ac.id](mailto:apriade.voutama@staff.unsika.ac.id)



## I. INTRODUCTION

The development of technology today has made many changes in people's lifestyles [1]. One of the changes is the increasing use of smartphones, especially those based on android, for daily life [2]. Smartphone users come from all walks of life and ages. Its benefits are diverse, such as browsing, social media, e-mail, playing games, etc. Android is currently one of the most popular mobile platforms in the world [3]. Its popularity is not only among mobile phone users but also among application developers. Android also seems to have become a community platform standard and must be developed sustainably [4]. Currently, Android users do not look at age, and every group has used and utilized various applications available on the Android platform [5].

The utilization of android technology in corporate and government agencies has not been maximized in the development of an open-source mobile platform that should be able to help and support the performance of the agency [6]. Like the State Electricity Company (PLN), which works and is responsible for the electricity sector and as a supporter of people's lives in Indonesia [7]. Complaints about public electricity, especially in the city of Padang to the local PLN, are still felt to be less than optimal in general; agencies still use introduction media and information in the form of websites or interact directly with customers so that service is still slow and not optimal, plus not many are using the Android technology platform as one of the one ways to communicate. Ease of communication is one aspect that must be met to provide a sense of comfort and satisfaction with the services of an agency [8].

One of the innovations that need to be developed is to create a Claim System for local PLN customers as a forum for communication and complaints about electricity problems in the community that are fast and precise. The system is made into two platforms, on the PLN internal platform in the form of a Website-based system and on customers using an Android-based platform [2]. Simulation of this Claim System when there is a power outage to the customer, access the Claim System application that has been installed on their smartphone, simply fill in the identity and electricity problem. The message will go directly to PLN's internal section through the Claim System page, and the party will immediately submit a customer complaint that this is a superior feature because it is enough to access the application via a smartphone directly; you can make a complaint quickly.

The development of the customer's Android-based Client Application Claim System related to electricity problems has never been created before; several previous related studies, such as the research of Prasetyo et al. [9] 2015 with the title "Design and Manufacture of Warehouse Information System (Case Study: PT. PLN (Persero) West Surabaya Area)" the results of the research that was built were creating a warehouse information system at PT PLN West Surabaya

area in this study the system made was still in the form of a website and has not become an android application. In Huda and Amelia's research in 2020, under the title "Implementation of the Goods Inventory Information System at PT. PLN (Persero) Palembang," the results of this research are in the form of developing and implementing an information system for the inventory of goods at PLN Palembang where this research is more focused on goods inventory on PLN Palembang company with a website-based system. In Tinto's research in 2020, with the title "Designing an SMS Gateway Application for the Distribution of PLN Power Outage Information," the results of the study in the form of designing an SMS Gateway for the distribution of information on power outages were in this study focused on providing services to the public or PLN electricity customers using SMS Gateway and do not use a website or android based system. Then in the research conducted by Junaedi and Suyantapa in 2020, "Designing an Information System Application for the Distribution of Electric Power Contact Center 123 Web-Based Jakarta Distribution Site," the results of the research, namely designing an information system for the distribution of electricity in the area where the focus of this research is to create a system website based. Based on previous research related to PLN's services to customers where previously it was still web-based, then by taking advantage of technological developments in the field, the goal to be achieved was to create an Android-based Claim System for customers by providing accessible and timely complaints through a complaint application that was already installed on the customer's smartphone.

This claim system development utilizes information system design tools, namely UML (Unified Modeling Language) and PHP (Hypertext Preprocessor) programming language with MySQL (My Structured Query Language) database as a database and by utilizing the Android Eclipse programming language. UML is one of the standard models widely used in the industrial world to define requirements, analyze and design, and describe architecture in object-oriented programming. [10]. UML is also a family of graphical notations supported by single models, which help define and develop software systems, especially object-oriented programming. Some UML diagrams used in the analysis phase are Use Case Diagrams describing an interaction between one or more actors and the information system that will be created. Roughly speaking, use cases determine what functions are in an information system and who has the right to use those functions. [11]. Activity Diagrams describe the workflow (workflow) or activities of a system. Sequence diagrams illustrate the behavior of use cases by describing the lifetime of objects and messages sent and received between objects. Class diagrams represent the system's structure in terms of defining the classes that will be created to build the system. Types have what are called attributes and methods or operations [12].

## II. RESEARCH METHOD

The research framework is used by utilizing disciplines that are widely used in computer science, namely the System Development Life Cycle (SDLC) [13]. SDLC determines how an information system is designed and built to be used in this development process. [14] [15]. The implementation model used is Rapid Application Development (RAD) [16] [17], a linear sequential model where rapid development is achieved by using a component-based construction approach [18].

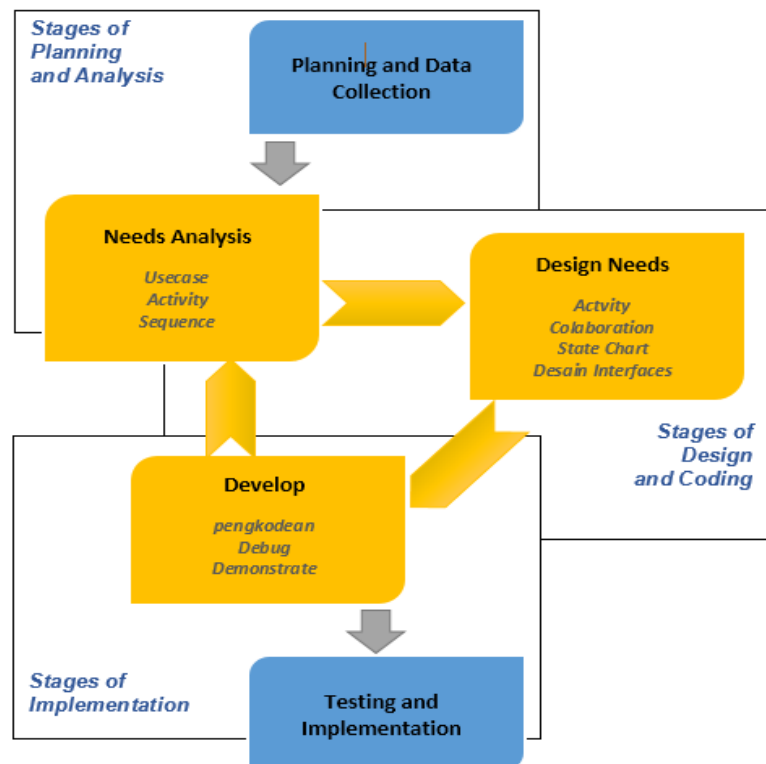
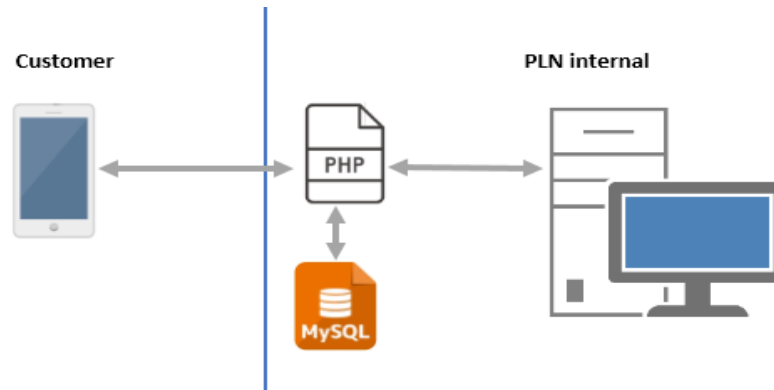

Figure 1. RESEARCH FRAMEWORK

### A. Planning and Data Collection

Based on Figure 1. In the early stages, planning is carried out by determining the system to be made, namely the Electrical Damage Claim System, so that data is needed as a reference for system development from the customer side and from the electricity company, namely PLN in this case the information is taken at PT. PLN (Persero) Padang Branch. In the planning process, several tools and tools are needed in the system development process, such as UML diagrams, PHP and MySQL programming languages, and the Android programming language. The following is an overview of the simulation built [19] [20].



**Figure 2.** CLAIM SYSTEM FLOW

From Figure 2. It can be seen that the flow of the complaint system runs where customers access applications that are already installed on smartphone devices, then input complaint data where the data will enter the PLN system where the system that has been built uses the PHP programming language and is stored in the MySQL database. It will automatically be displayed on a web-based application on the computer screen by providing notifications so that PLN internal parties can find out and respond quickly.

### **B. Analysis**

The analysis stage is the process of carrying out a picture analysis of the claims system requirements that will be built at this stage using several diagrams as a general description of the system being built. The model diagram used to show the system's initial design, namely the Use Case model, is used for the initial analysis between the system and the actors involved. The Activity Model is an overview diagram and activity flow for each actor based on a Use Case and will be completed in more detail using a Sequence Diagram [21].

### **C. Design**

The stage where the analysis stage is completed in this stage; will be continued with an advanced design process which will show several advanced diagram models as well as an overview of the user interface design and the structure of the database design to be built.

### **D. Develop**

The Develop stage is the execution stage of the design results that have been built and translated into a system that is expected by using a predetermined programming language. And at this stage, program testing will be carried out both from the System side for internal PLN and from the customer application side; if coding or debugging errors are found, they are immediately corrected, so the design continues.

**E. Testing and Implementation**

This stage is the final stage, namely program testing using the black box testing [22] method by testing the functional outside of each application page [23] [24] and testing directly involving users by conducting a demo program that has been built whether it is feasible or not later it can be implemented to users, both customers and parties [25] [26]. PLN to see how far the system that has been built has achieved its goals and will further develop it.

**III. RESULT AND DISCUSSION**

**A. Requirement Plan**

The design begins by using several models. In the early stages of the invention, determine the actors involved, the description of the system to be built, and the relationship between the two [21] [27]. Actors in this system are Admin, Customer, and Deputy, who will see the admin report [28]. The following is an overview of the Usecase design [29].

**Table 1.** USE CASE COMPONENTS

Use Case	Description
Registration	It is reserved for the customer to gain access rights to the system.
Login	Is checking the access rights of actors who will enter the system. In this case, there are customers, admins, and users/deputies.
Make menu selection	Customers choose the menu in the application
Complaint management	Admin processes complaints made by customers
Admin management	Change the password or username on the Admin
View reports	View reports of all complaints made by customers.
View customer data	View the data of customers who have made complaints.

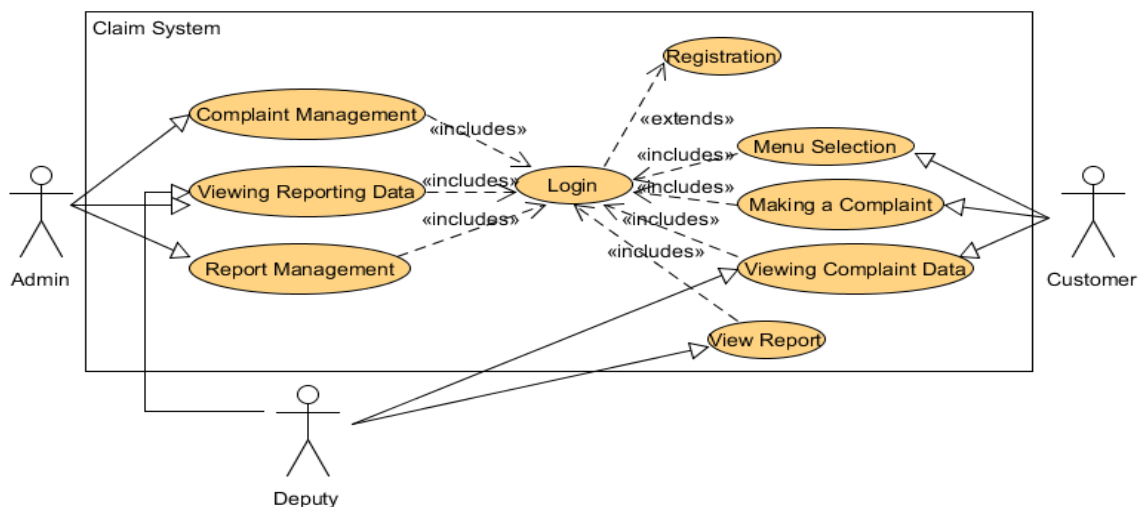

**Figure 3.** USE CASE DESIGN

In Figure 3. Shows an overview of the Use Case Diagram design based on table 1 with three actors involved in the system; from the figure, it can be seen that several Use Cases with relationship rules are built based on the needs of each actor. [30].

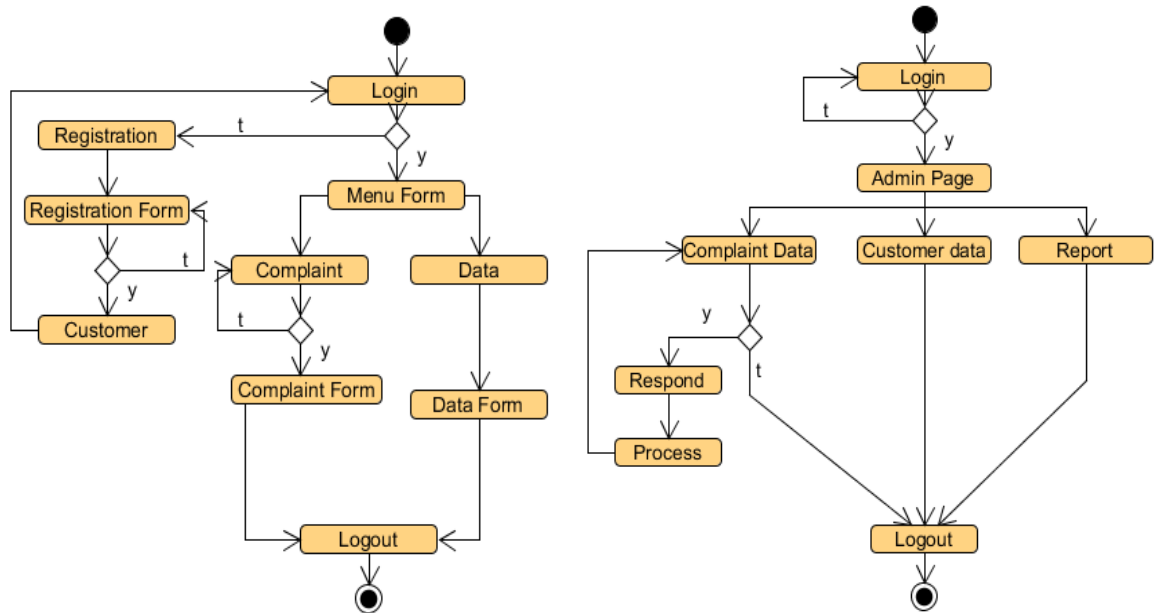

**Figure 4. CUSTOMER AND ADMIN ACTIVITY DESIGN**

The activity diagram shown in Figure 4. illustrates the various activities flow in the designed system, where each flow begins, the decisions that may occur, and how they end. [31]. Customer and Admin Activity Diagrams describe all the activities that can be performed on the system.

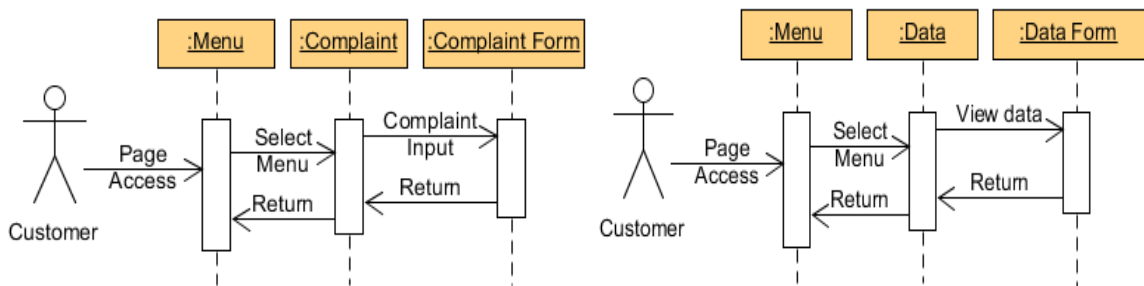

**Figure 5. CUSTOMER COMPLAINTS PROCESS SEQUENCE**

The next step is to carry out a more detailed analysis design of the Activity model using Sequence Diagrams. The following Figure 5. is a diagram of the complaint process. This diagram explains the sequence of steps the customer takes when making a complaint and what the customer does when they want to complain or submit a complaint.

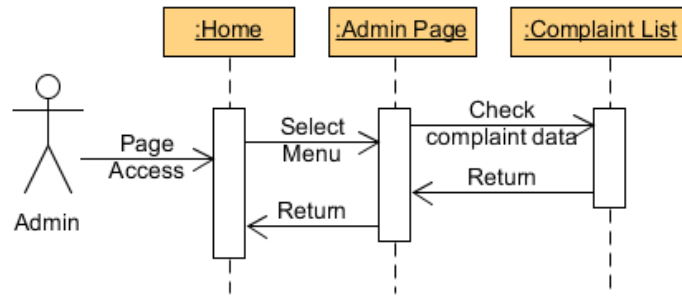

**Figure 6.** SEQUENCE ADMIN MANAGES COMPLAINTS DATA

This diagram describes the activities carried out by the Admin in managing customer complaints.

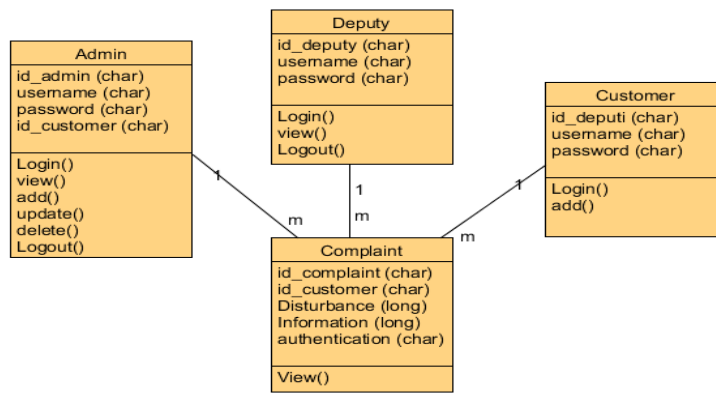

**Figure 7.** CLASS DIAGRAM

Next is the Design Stage, a continuation of the analysis stage using several auxiliary models in the design process. In Figure 7, this stage describes the Class Diagram, which was designed based on the previous models. Class diagrams represent the types of objects in the system and the various static relationships between systems [32].

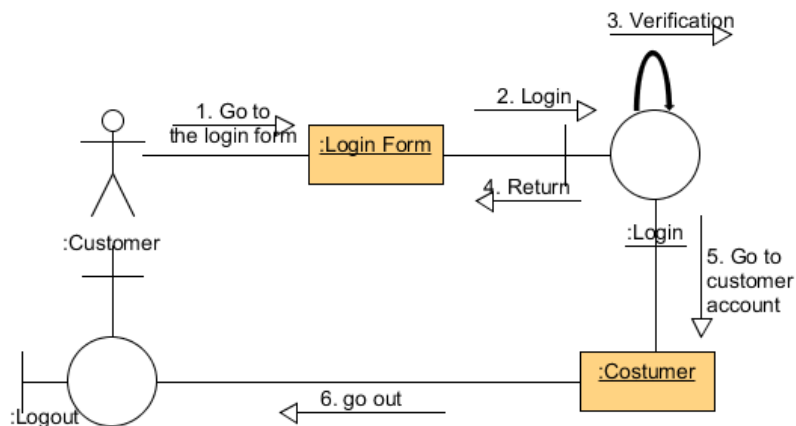

**Figure 8.** COLLABORATION MODEL REGISTER AND LOGIN



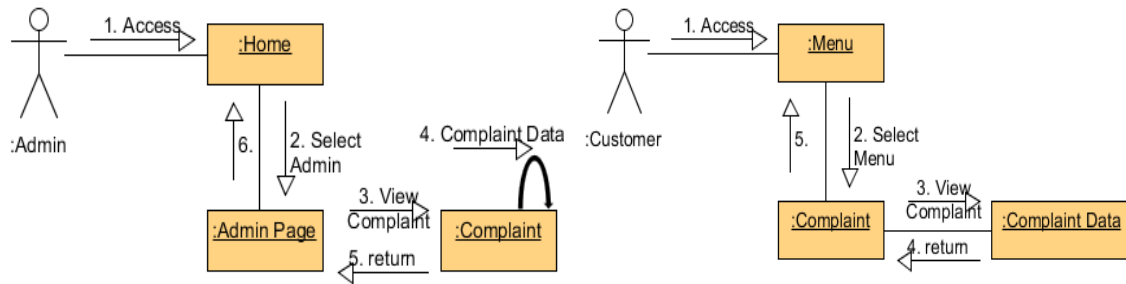

**Figure 9.** COLLABORATION MODEL COMPLAINTS ACTIVITY

In Figure 9, the Collaboration Diagram's design further explains how the administrator manages complaints and how the customer complaint process occurs.

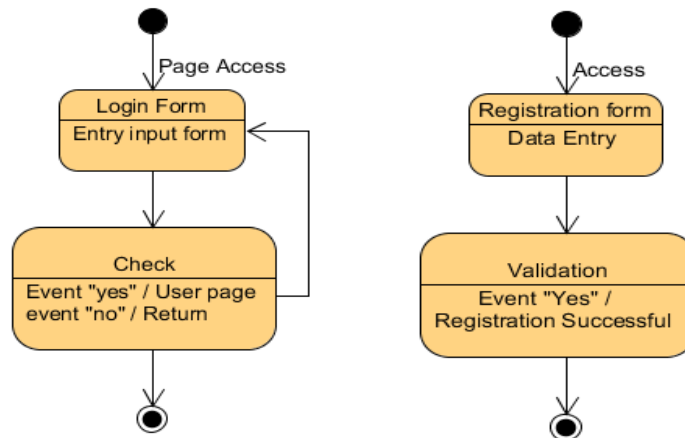

**Figure 10.** STATE CHART MODEL LOGIN AND REGISTER

In the State Chart Diagram shown in Figure 10. this is a state change. If the login process is successful, the next feature will be able to be used; if it fails, an error message will appear.

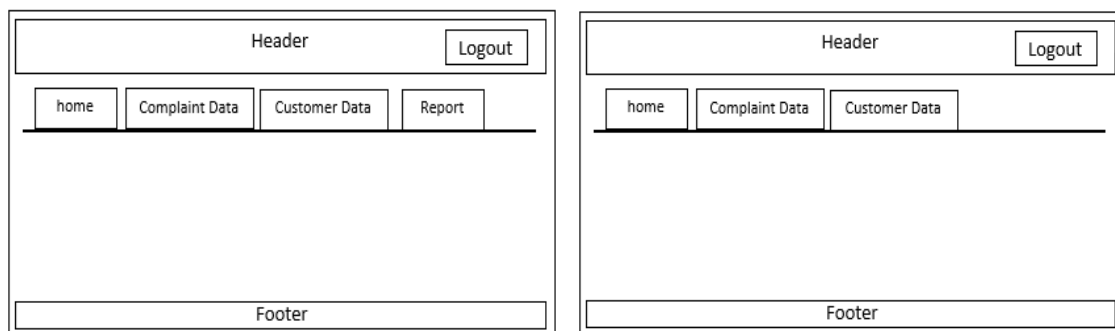

**Figure 11.** ADMIN AND DEPUTY PAGE INTERFACE DESIGN

User Interface Design can be seen in Figure 11. illustrates the design of the display both from the side of the Admin web page and the android page on the customer [33]. The admin login design is the initial form before entering the main page, and those who can log in on this page are

admins and deputies. If you successfully log in, you will join the central panel of the Admin page. Design that informs the main program where there will be menus, headers, home, complaints, customer data, reports, and footers. Meanwhile, on the Deputy's page, you will be able to see the status of the message where customers see whether their order has been processed or not.

Registration	
PLN Account id	-----
Customer name	-----
Address	-----
Phone	-----
Password	-----
Register	

Id	-----
Password	-----
Login	
Registration	

**Figure 12.** ANDROID-BASED CUSTOMER LOGIN AND REGISTER INTERFACE DESIGN

In Figure 12. Interphase Design on the Customer will adjust to the appearance of the android that will be designed. The customer registration design is a form the customer will fill out when registering or registering. After registering, the customer can log in on the login page.

Welcome
Complaint
Verification
Logout

Header
Complain
Information
Send
Logout

**Figure 13.** CUSTOMER COMPLAINTS PAGE INTERFACE DESIGN

In Figure 13. The design of the customer complaint page is a form for customers to choose a menu to run, one of which is the complaint menu which is a form for customers to complain.

## B. Program Results

The design that has been made next is the process of coding or translating the results of the design into a claim system with an android-based client application [21]. The display of the program results is divided into two parts: the admin section using a website-based system and the customer application that is used based on android. The following is a display of the Customer Claim System Website-based Admin page where the admin logs in and enters the main page of the claim system panel.



**Figure 14.** ADMIN LOGIN PAGE DISPLAY

After logging in, as shown in Figure 14, by inputting data such as Id, Username, and Password, the system will validate if the data is correct, then enter the main page of the Customer Claims panel. In this view, the Admin can see the data of registered customers and the customer data as an internal party of the company.



**Figure 15.** ADMIN PAGE VIEW CUSTOMER DATA

Furthermore, the Admin can see customer complaint data, as shown in Figure 15. At this stage, the Admin can respond and reply to complaints and take action quickly and precisely according to the problem.



**Figure 16.** ADMIN VIEW VIEW CUSTOMER COMPLAINTS DATA

In Figure 16. Admin can see customer activities when using the electricity claim system using an Android-based application already installed on a smartphone.

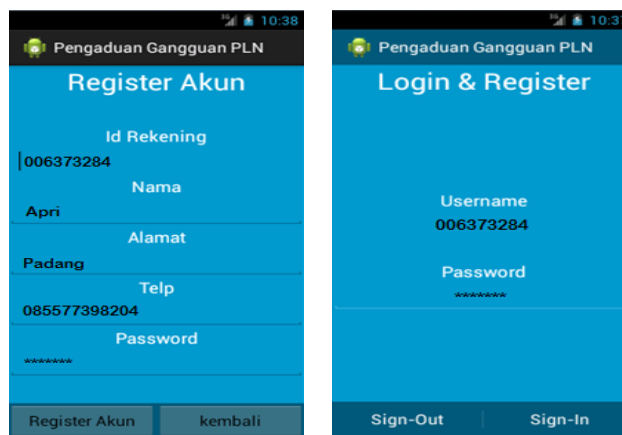

**Figure 17.** CUSTOMER VIEW DOING REGISTER AND LOGIN

On the customer side, the Android-based display is shown in Figure 17. Customers who have registered can log in and complain about problems that occur regarding electricity in their place. The message created will be entered as a notification to the Claim System and can be immediately known by the Admin from the company's internal party.



**Figure 18.** CUSTOMER VIEW REPORTING COMPLAINTS

In Figure 18. The following displays the superior features of the claims application, namely the complaint section; when a customer makes a complaint, it will automatically enter the claim system on the inner side of the company. From these complaints, prompt and appropriate action will be taken so that customers no longer have difficulty reporting problems related to electricity in their place.

### C. Analysis of Test Results

The results were analyzed to determine the level of success and user satisfaction from the company's internal parties and customers for this Electric Claim System application. They use two methods: black box testing of the equivalence partitions technique [34] [26] and testing to users by testing the distribution of questionnaires. The following is a black box with the equivalence Partitions technique that determines the application's functional outer side by setting the following Test Case test table.

**Table 2.** RESPONDENT SATISFACTION LEVEL QUESTIONNAIRE

No	Test Case	Expected results	Test result	Conclusion
T01	Open admin panel 1. Login page: OK 2. Id: Admin 3. Username: Apriade 4. Enter Pass:apriade123	The system displays the main admin page	The system displays the main admin page (Figure 14)	OK
T02	Admin panel login 1. Home: OK 2. Select Menu: OK 3. Customer Data: OK	The system displays the customer data table	The system displays the customer data table (Figure 15)	OK
T03	Admin panel login 1. Home: OK 2. Select Menu: OK 3. Complaint Data: OK 4. Action: OK	The system displays a table of complaints/nuisance data	The system displays a table of complaints/nuisance data (Gambar 16)	OK
T04	Access the user's claim application 1. Register page: OK 2. Input Id_rek: 006373284 3. Input name: apri 4. Input address: Padang 5. Phone: 085577398204 6. Input password: *****	The system saves data to the database	The system holds data in the database (Figure 17)	OK
T05	Access the user's claim application 1. Login page: OK 2. Username: 006373284 3. Password: apri 4. Request: OK	The system displays the user's main page	The system displays the user's main page (Figure 18)	OK
T06	User claim Login 2. Complaint: 0012688 3. Submission Input: OK 4. Input Description: OK 5. Send: OK	The system saves data and notifications to PLN's internal system	The system keeps data and reports to PLN's internal system (Figure 18)	OK

The results of table 2 show the expected black box testing framework following the testing on the program. Some tests were conducted outside the functional program and offered the appropriate results and functions. Further testing is carried out by involving users, as shown in Table 3 below.

**Table 3.** RESPONDENT SATISFACTION LEVEL QUESTIONNAIRE

Questions	Rating		
	Bad	Good	Excellent
How do you rate this Electrical Damage Network Claim System?	0	3	22
How do you rate the ease of using this Claim System?	0	4	21
How do you rate the visual appearance of this Claims System?	0	5	50
How do you rate the features in this Claim System?	1	9	15
How do you rate the speed or accuracy when this application is running?	1	5	19

From the results of table 3 above, it can be described as a conclusion chart so that the overall presentation results can be seen.



**Figure 19.** USER SATISFACTION LEVEL

Based on Figure 16, the level of user satisfaction in using the electrical network claim system, both from the admin system and applications that customers have used via smartphones, obtained user satisfaction results at the Excellent level reaching 78%, the Good level going 21%, and the Bad level only 2% from 35 respondent data. So that with the achievement of an Excellent level reaching 78%, the claims system that has been built gets an outstanding response and can be implemented on an ongoing basis.

#### IV. CONCLUSION

The electricity network claim system is designed to provide accessible communication from both PLN and customers so that electrical problems that occur in the community can be reported easily so that PLN can respond quickly and accurately. Android-based applications intended for

customers can make it easier for companies to carry out customer reporting services, which so far have only been through reports by visiting the nearest office and customer information from one customer to another. With the existence of this Claim System, it can make it easier for the PLN company to deal with disruptions from customer electricity services quickly and precisely. Based on the results of the analysis of testing the system that has been built, it gets an outstanding response with a complete satisfaction level of 78%, so the plan is feasible to be used and implemented on an ongoing basis. In the future, the system that has been developed can be further refined by adding more exclusive features. The level of Bad satisfaction with a presentation value of 2% is not on the system's function. However, it is a simple feature, so it is feasible to further develop it into a complex system with more complete features.

## REFERENCES

- [1] N. Huda and R. Amalia, "Implementasi Sistem Informasi Inventaris Barang pada PT.PLN (Persero) Palembang," *J. Sisfokom (Sistem Inf. dan Komputer)*, vol. 9, no. 1, pp. 13–19, 2020, doi: 10.32736/sisfokom.v9i1.674.
- [2] A. Voutama, I. Maulana, and N. Ade, "Interactive M-Learning Design Innovation using Android-Based Adobe Flash at WFH (Work From Home)," *Sci. J. Informatics*, vol. 8, no. 1, pp. 127–136, 2021, doi: 10.15294/sji.v8i1.27880.
- [3] A. Sopandi, "Design and Development of Correspondence Management Application Based on Android," 2019 7th Int. Conf. Cyber IT Serv. Manag. CITSM 2019, pp. 5–10, 2019, doi: 10.1109/CITSM47753.2019.8965399.
- [4] F. N. Fadhlurrohman, N. A. S. Winarsih, M. S. Rohman, and G. W. Saraswati, "User interface design for solar panel monitoring system on android smartphones using user-centered design method," *Proc. - 2020 Int. Semin. Appl. Technol. Inf. Commun. IT Challenges Sustain. Scalability, Secur. Age Digit. Disruption, iSemantic 2020*, pp. 625–629, 2020, doi: 10.1109/iSemantic50169.2020.9234266.
- [5] R. V Golhar, P. A. Vyawahare, P. H. Borghare, and A. Manusmare, "Mobile App For an Institute," *Int. Conf. Electr. Electron. Optim. Tech.*, pp. 3660–3663, 2016.
- [6] S. Khan, Z. Jiangbin, and A. Wahab, "Design and Development of Android Performance Testing Tool," 2020 IEEE Conf. Big Data Anal. ICBDA 2020, pp. 57–60, 2020, doi: 10.1109/ICBDA50157.2020.9289714.
- [7] M. D. A. Rusbandi, I. Aknuranda, and ..., "Pengembangan Sistem Informasi Penyambungan Baru Listrik Khusus Pelanggan Getting Electricity Berbasis Web Pada Pt. Pln (Persero) Distribusi Jawa Timur Area ...," *J. Pengemb. ...*, vol. 3, no. 3, pp. 2286–2294, 2019, [Online]. Available: <http://j-ptiik.ub.ac.id/index.php/j-ptiik/article/view/4640>.
- [8] I. Junaedi and Suyantapa, "Perancangan Aplikasi Sistem Informasi Pendistribusian Tenaga Listrik Contact Center PLN 123 Site Distribusi Jakarta Berbasis Web," *JSI (Jurnal Sist. Informasi) Univ. Suryadarma*, vol. 7, no. 2, pp. 149–170, 2020.
- [9] B. Prasetyo, T. J. Pattiasina, and A. N. Soetarmono, "Perancangan dan Pembuatan Sistem Informasi Gudang (Studi Kasus : PT. PLN (Persero) Area Surabaya Barat)," *Teknika*, vol. 4, no. 1, pp. 12–16, 2015, doi: 10.34148/teknika.v4i1.30.
- [10] S. Gotti and S. Mbarki, "UML executable: A comparative study of UML compilers and interpreters," 2016 Int. Conf. Inf. Technol. Organ. Dev. IT4OD 2016, 2016, doi: 10.1109/IT4OD.2016.7479251.

- [11] E. E. Zarwono and A. N. Hidayanto, "Analysis and Design of Internal Information Systems of the APU-PPT Education and Training Center Using the User-Centered Design Method," *Proc. - 2nd Int. Conf. Informatics, Multimedia, Cyber, Inf. Syst. ICIMCIS 2020*, pp. 159–165, 2020, doi: 10.1109/ICIMCIS51567.2020.9354312.
- [12] A. Wichmann, R. Maschotta, F. Bedini, and A. Zimmermann, "Model-driven development of UML-based domain-specific languages for system architecture variants," *SysCon 2019 - 13th Annu. IEEE Int. Syst. Conf. Proc.*, pp. 1–8, 2019, doi: 10.1109/SYSCON.2019.8836895.
- [13] M. M. Swastikasari, E. Sedyono, and A. S. Ardjo, "Design of E-KOST: An Android-based mobile application using location based service (Study case: SWCU'S students)," *Proc. - 2017 Int. Conf. Innov. Creat. Inf. Technol. Comput. Intell. IoT, ICITech 2017*, vol. 2018-Janua, pp. 1–9, 2018, doi: 10.1109/INNOCIT.2017.8319135.
- [14] G. U. Guskov, A. M. Namestnikov, and N. G. Yarushkina, "The system of searching similar software projects, based on the ontology constructed by UML metascheme and design patterns," *RPC 2018 - Proc. 3rd Russ. Conf. Comput. Technol. Appl.*, pp. 1–4, 2018, doi: 10.1109/RPC.2018.8482154.
- [15] A. Heryana, E. Nugraheni, B. Kusumo, A. F. Rojie, and B. Setiadi, "Applying agile methods in designing an earthquake and landslide early warning system application for Android," *Proc. - 2017 Int. Conf. Comput. Control. Informatics its Appl. Emerg. Trends Comput. Sci. Eng. IC3INA 2017*, vol. 2018-Janua, no. 1, pp. 80–84, 2017, doi: 10.1109/IC3INA.2017.8251744.
- [16] J. Wahslen and T. Lindh, "A javascript web framework for rapid development of applications in IoT systems for eHealth," *2018 IEEE 20th Int. Conf. e-Health Networking, Appl. Serv. Heal. 2018*, 2018, doi: 10.1109/HealthCom.2018.8531124.
- [17] R. Rosyad, A. Syukur, Busro, and R. Rahim, "Multimedia Prayer Application for Education with Rapid Application Development Method," *2019 7th Int. Conf. Cyber IT Serv. Manag. CITSM 2019*, pp. 3–6, 2019, doi: 10.1109/CITSM47753.2019.8965379.
- [18] Y. Hou, "Design and implementation of the framework for Spring+SpringMVC+MyBatis in the development of web application," *Proc. - 2017 Int. Conf. Comput. Technol. Electron. Commun. ICCTEC 2017*, pp. 368–371, 2017, doi: 10.1109/ICCTEC.2017.00085.
- [19] A. Voutama, "Perancangan Aplikasi M-Discussion Berbasis Android Sebagai Wadah Diskusi Sekolah," *Syntax J. Inform.*, vol. 7, no. 2, pp. 116–124, 2018.
- [20] W. Shin, J. L. Lee, D. H. Park, and C. H. Chang, "Design of authenticity evaluation metric for Android applications," *2014 4th Int. Conf. Digit. Inf. Commun. Technol. Its Appl. DICTAP 2014*, pp. 275–278, 2014, doi: 10.1109/DICTAP.2014.6821695.
- [21] Y. Zhang, C. Yan, Y. Li, and W. Wang, "Design of Fault Diagnosis System for Steam Turbine Based on UML," *Proc. - 11th Int. Conf. Progn. Syst. Heal. Manag. PHM-Jinan 2020*, pp. 254–260, 2020, doi: 10.1109/PHM-Jinan48558.2020.00052.
- [22] I. Sudirman, I. Sunaryo, A. Aisha, J. Monang, and I. R. Prasetyo, "A Website-based Information System Design of SME Development Facilitation Registration," *INTENSIF J. Ilm. Penelit. dan Penerapan Teknol. Sist. Inf.*, vol. 5, no. 2, pp. 218–233, 2021, doi: 10.29407/intensif.v5i2.15399.
- [23] E. Novalia and A. Voutama, "Black Box Testing dengan Teknik Equivalence Partitions Pada Aplikasi Android M-Magazine Mading Sekolah," vol. 11, no. 11, pp. 23–34, 2022.
- [24] Y. Hao and F. Liu, "Application of Fuzzy Equivalence Relation Kernel Clustering Algorithm to Car Evaluation," *Proc. 2018 IEEE Int. Conf. Saf. Prod. Informatiz. IICSPI 2018*, pp. 591–594, 2019, doi: 10.1109/IICSPI.2018.8690512.
- [25] M. Shupletsov and M. Avtaikina, "Dynamic programming algorithms for large-scale equivalence checking and functional correction," *Proc. 2017 IEEE Russ. Sect. Young Res. Electr. Electron. Eng. Conf. ElConRus 2017*, pp. 1032–1035, 2017, doi: 10.1109/ElConRus.2017.7910732.



- [26] R. Mukherjee, D. Kroening, T. Melham, and M. Srivas, "Equivalence checking using trace partitioning," *Proc. IEEE Comput. Soc. Annu. Symp. VLSI, ISVLSI*, vol. 07-10-July, pp. 13–18, 2015, doi: 10.1109/ISVLSI.2015.110.
- [27] D. Shrestha, T. Wenan, S. Maharjan, B. Gaudel, J. Chun, and S. R. Jeong, "A UML based approach for analysis and design of tourism web portal," *Proc. - Int. Conf. Smart Electron. Commun. ICOSEC 2020*, no. Icosec, pp. 236–243, 2020, doi: 10.1109/ICOSEC49089.2020.9215380.
- [28] A. Herawan, E. Rachim, and S. S. U. Sutjipto, "Design of LAPAN-A2 Satellite Telemetry Data Information System Using SDLC," *INTENSIF J. Ilm. Penelit. dan Penerapan Teknol. Sist. Inf.*, vol. 6, no. 1, pp. 43–55, 2022, doi: 10.29407/intensif.v6i1.16149.
- [29] I. Riadi, S. Sunardi, and F. T. Fitri, "Spamming Forensic Analysis Using Network Forensics Development Life Cycle Method," *INTENSIF J. Ilm. Penelit. dan Penerapan Teknol. Sist. Inf.*, vol. 6, no. 1, pp. 108–117, 2022, doi: 10.29407/intensif.v6i1.16830.
- [30] Z. A. Hamza and M. Hammad, "Generating Test Sequences from UML Use Case Diagram: A Case Study," *2020 2nd Int. Sustain. Resil. Conf. Technol. Innov. Build. Des.*, pp. 1–6, 2020, doi: 10.1109/IEEECONF51154.2020.9319979.
- [31] C. Shi and H. Ge, "The application of uml in the modeling of automation laboratory management system," *Proc. - 2020 Int. Conf. Intell. Transp. Big Data Smart City, ICITBS 2020*, pp. 816–819, 2020, doi: 10.1109/ICITBS49701.2020.00179.
- [32] W. Naiyapo and W. Jumpamule, "An event driven approach to create UML models," *2018 22nd Int. Comput. Sci. Eng. Conf. ICSEC 2018*, pp. 1–5, 2018, doi: 10.1109/ICSEC.2018.8712621.
- [33] Z. Xinyu and S. Jinyu, "Design and development of campus dating social application based on android," *Proc. 2nd IEEE Int. Conf. Eng. Technol. ICETECH 2016*, no. March, pp. 1241–1244, 2016, doi: 10.1109/ICETECH.2016.7569450.
- [34] G. Wu, Y. T. Sun, and J. H. R. Jiang, "Design partitioning for large-scale equivalence checking and functional correction," *Proc. - Des. Autom. Conf.*, vol. 05-09-June, 2016, doi: 10.1145/2897937.2898004.